

STANFIELD

2008 Stylus Catalogue





Locked Bag 30
138 Liverpool Rd
Ashfield 2131

QUALITY PRODUCTS and ACCESSORIES



PLEASE READ ME!

BELTS

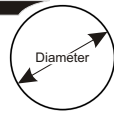

Suit Cassette, Portable, Dictation machines, Personal Audio, 3in1, Turntable, CD, and maybe some Reel to Reel. For Video it is advised that you use only original part No's in section four.

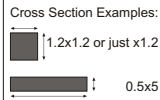

Please take care in measuring and selecting the correct size of belt. Extract and squeeze the belt together, measure its length then double it to give you the belts total length. Note: **Do Not Order using the Length value.** From the tables listed, read off the diameter. This is the value used in our codes. Choose the next size down if the belt is stretched. The thickness is a measure of the cross-section of the belt. If the belt is missing or damaged beyond recovery then you could duplicate the belt by running a piece of string around the mech' and use its length as a general guide. Please take advantage of our discount structure. The belts are available individually but are 10% cheaper if bought in bag quantities of ten (No mixed values).

WHEN ORDERING QUOTE THE DIAMETER & THICKNESS ONLY

e.g. **195x0.5x5** 195mmØ, 0.5x5mm thick. (612mm long)
80x1.2 80mmØ, 1.2mm thick. (251mm long)

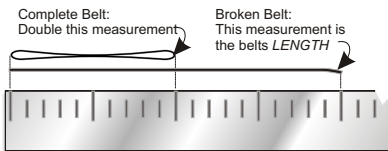

Remember to allow for the old belt to have been stretched.

SQUARE SECTION 1.0mm X 1.0mm

Code	Length
10X1	31 mm
12X1	38 mm
13X1	41 mm
15X1	47 mm
17X1	54 mm
19X1	60 mm
22X1	69 mm
25X1	79 mm
27X1	84 mm
31X1	97 mm
33X1	103 mm
35X1	110 mm
37X1	116 mm
40X1	125 mm
43X1	135 mm
46X1	144 mm
49X1	154 mm
51X1	160 mm
54X1	169 mm
57X1	179 mm
60X1	188 mm
63X1	198 mm
66X1	207 mm
69X1	216 mm
72X1	226 mm
75X1	235 mm
122X1	380 mm

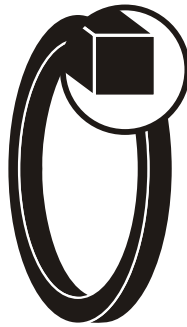

SQUARE SECTION 1.4mm X 1.4mm

Code	Length
10X1.4	31 mm
12X1.4	38 mm
13X1.4	41 mm
15X1.4	47 mm
17X1.4	54 mm
19X1.4	60 mm
22X1.4	69 mm
25X1.4	79 mm
27X1.4	84 mm
31X1.4	97 mm
33X1.4	103 mm
35X1.4	110 mm
37X1.4	116 mm
37.3X1.6	***
40X1.4	125 mm
43X1.4	135 mm
46X1.4	144 mm
49X1.4	154 mm
51X1.4	160 mm
54X1.4	169 mm
57X1.4	179 mm
60X1.4	188 mm
63X1.4	198 mm
66X1.4	207 mm
69X1.4	216 mm
72X1.4	226 mm
75X1.4	235 mm
80X1.4	251 mm
85X1.4	267 mm
90X1.4	282 mm
95X1.4	298 mm
97X1.4	305 mm
100X1.4	314 mm
105X1.4	330 mm
110X1.4	346 mm
115X1.4	361 mm
121X1.4	380 mm
127X1.4	399 mm
131X1.4	412 mm
136X1.4	427 mm

*** CD loading belt Suit Sony, etc.

SQUARE SECTION 0.8mm x 0.8mm

Code	Length
10X.8	31 mm
12X.8	38 mm
13X.8	41 mm
15X.8	47 mm
17X.8	54 mm
19X.8	60 mm
22X.8	69 mm
25X.8	79 mm
27X.8	84 mm
31X.8	97 mm
33X.8	103 mm
35X.8	110 mm
37X.8	116 mm
40X.8	125 mm
43X.8	135 mm
46X.8	144 mm
49X.8	154 mm
51X.8	160 mm
54X.8	169 mm
57X.8	179 mm
60X.8	188 mm
63X.8	198 mm
66X.8	207 mm
69X.8	216 mm
72X.8	226 mm
75X.8	235 mm



SQUARE SECTION 1.2mm X 1.2mm

Code	Length
10X1.2	31 mm
12X1.2	38 mm
13X1.2	41 mm
15X1.2	47 mm
17X1.2	54 mm
19X1.2	60 mm
22X1.2	69 mm
25X1.2	79 mm
26.5X1.2	*Clarion
27X1.2	84 mm
31X1.2	97 mm
33X1.2	103 mm
35X1.2	110 mm
37X1.2	116 mm
40X1.2	125 mm
43X1.2	135 mm
46X1.2	144 mm
49X1.2	154 mm
51X1.2	160 mm
54X1.2	169 mm
57X1.2	179 mm
60X1.2	188 mm
63X1.2	198 mm
66X1.2	207 mm
69X1.2	216 mm
72X1.2	226 mm
73X1.2	229 mm
75X1.2	235 mm
80X1.2	251 mm
85X1.2	267 mm
90X1.2	282 mm
95X1.2	298 mm
97X1.2	305 mm
100X1.2	314 mm
105X1.2	330 mm
110X1.2	346 mm
115X1.2	361 mm
116X1.25	**Suit Philips
121X1.2	380 mm
127X1.2	399 mm
131X1.2	412 mm
136X1.2	427 mm

SQUARE SECTION 2.0mm X 2.0mm

Code	Length
10X2	31 mm
12X2	38 mm
13X2	41 mm
14X2	44 mm
16X2	51 mm
18X2	57 mm
19X2	60 mm
22X2	69 mm
25X2	79 mm
27X2	84 mm
31X2	97 mm
33X2	103 mm
35X2	110 mm
37X2	116 mm
39X2	120 mm
40X2	125 mm
43X2	135 mm
46X2	144 mm
49X2	154 mm
51X2	160 mm
54X2	169 mm
57X2	179 mm
60X2	188 mm
63X2	198 mm
66X2	207 mm
69X2	216 mm
72X2	226 mm
75X2	235 mm
80X2	251 mm
85X2	267 mm
90X2	282 mm
93X2	292 mm
95X2	298 mm
97X2	305 mm
100X2	314 mm
105X2	330 mm
110X2	346 mm
115X2	361 mm
121X2	380 mm
127X2	399 mm





FLAT SECTION BELTS 0.5x3mm

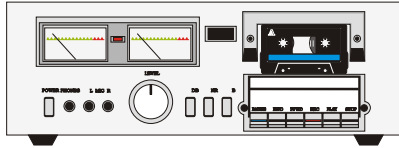

Please Read the **BELTS**
 On The Previous Page
 for Instructions!

Code	Length
31X.5X3	97mm
33X.5X3	103mm
35X.5X3	110mm
37X.5X3	116mm
43X.5X3	135mm
46X.5X3	145mm
49X.5X3	154mm
51X.5X3	160mm
54X.5X3	169mm
57X.5X3	179mm
60X.5X3	188mm
63X.5X3	198mm
66X.5X3	207mm
69X.5X3	216mm
72X.5X3	226mm
75X.5X3	235mm
80X.5X3	251mm
85X.5X3	267mm
90X.5X3	282mm
95X.5X3	298mm
100X.5X3	314mm
105X.5X3	330mm
110X.5X3	346mm
115X.5X3	361mm
121X.5X3	380mm

FLAT SECTION BELTS 0.6x5mm

Code	Length
31X.6X5	97mm
35X.6X5	110mm
37X.6X5	116mm
40X.6X5	125mm
43X.6X5	135mm
46X.6X5	145mm
51X.6X5	160mm
54X.6X5	169mm
57X.6X5	179mm
60X.6X5	188mm
63X.6X5	198mm
66X.6X5	207mm
69X.6X5	216mm
72X.6X5	226mm
75X.6X5	235mm
80X.6X5	251mm
85X.6X5	267mm
90X.6X5	282mm
95X.6X5	298mm
100X.6X5	314mm
105X.6X5	330mm
110X.6X5	346mm
115X.6X5	361mm
120X.6X5	377mm
126X.6X5	395mm
132X.6X5	415mm
143X.6X5	450mm
150X.6X5	471mm
160X.6X5	502mm
170X.6X5	534mm
175X.6X5	550mm
180X.6X5	565mm
185X.6X5	581mm
189X.6X5	593mm
195X.6X5	612mm
200X.6X5	628mm
205X.6X5	644mm
210X.6X5	659mm
222X.6X5	697mm
238X.6X5	748mm
262X.6X5	823mm

FLAT SECTION BELTS 0.6x6mm

57X.6X6	179mm
60X.6X6	188mm
63X.6X6	198mm
66X.6X6	207mm
69X.6X6	216mm
72X.6X6	226mm
75X.6X6	235mm
80X.6X6	251mm
85X.6X6	267mm
90X.6X6	282mm
95X.6X6	298mm
100X.6X6	314mm
105X.6X6	330mm
110X.6X6	346mm
115X.6X6	361mm
120X.6X6	380mm
122X.6X6	385mm
126X.6X6	395mm
132X.6X6	414mm
143X.6X6	449mm
150X.6X6	471mm
160X.6X6	502mm
170X.6X6	534mm
175X.6X6	550mm
180X.6X6	565mm
185X.6X6	581mm
189X.6X6	593mm
195X.6X6	612mm
200X.6X6	628mm
205X.6X6	644mm
210X.6X6	659mm

SUGGESTION:

Belt Missing?
 Measure the
 inner-platter
 diameter!
 This will give
 you an approx'
 Belt Diameter.
 Pick the next size down.



FLAT SECTION BELTS 0.5x4mm

Code	Length
31X.5X4	97mm
33X.5X4	103mm
35X.5X4	110mm
37X.5X4	116mm
40X.5X4	125mm
43X.5X4	135mm
46X.5X4	145mm
49X.5X4	154mm
51X.5X4	160mm
54X.5X4	169mm
57X.5X4	179mm
60X.5X4	188mm
63X.5X4	198mm
66X.5X4	207mm
69X.5X4	216mm
72X.5X4	226mm
75X.5X4	235mm
80X.5X4	251mm
85X.5X4	267mm
90X.5X4	282mm
95X.5X4	298mm
100X.5X4	314mm
105X.5X4	330mm
110X.5X4	346mm
115X.5X4	361mm
121X.5X4	380mm



175X.5X4	550mm
180X.5X4	565mm
185X.5X4	581mm
189X.5X4	593mm
195X.5X4	612mm
200X.5X4	628mm
205X.5X4	644mm

FLAT SECTION BELTS 0.5x5mm

Code	Length
120X.5X5	377mm
126X.5X5	395mm
132X.5X5	415mm
143X.5X5	450mm
150X.5X5	471mm
160X.5X5	502mm
170X.5X5	534mm
175X.5X5	550mm
180X.5X5	565mm
185X.5X5	581mm
189X.5X5	593mm
195X.5X5	612mm
200X.5X5	628mm
205X.5X5	644mm
210X.5X5	659mm
222X.5X5	697mm
238X.5X5	739mm
262X.5X5	823mm
292X.5X5	917mm

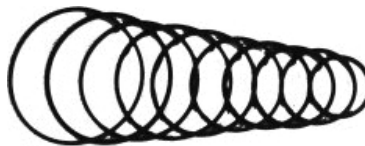

CD LOADING BELT 38x1.6mm

Suit Sony HD, HCDH, & Many others
 Size 37.3x1.6mm
 Orig. 4-927-649-01
 Code BLT4901



SHARP CD SLED 18x.5x3

18x.5x3
 APPROX
 Code BLT117



CAR AUTO-REVERSE 122x1

Popular belt used
 in many brands of
 car cassette like
 Eurovox, Clarion,
 and many others.
 Code 122X1X1

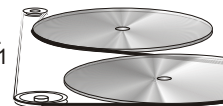

PHILIPS CAR PLASTIC MECH

Belt to suit
 popular mech P1.
 See Fly wheels
 next page....

116.5X1.25



STANFIELD

 <p>Ortofon 1918 Denmark. Vinyl Preservation Academy. For more Data & Specifications see www.ortofon.dk</p>	<p>CERAMIC CARTRIDGE</p> <p>Standard Stereo Type Code PC20</p>  <p>REPLACEMENT STYLUS D325</p>
<p>ORTOFON GT CARTRIDGE</p> <p>DJ MIX & SCRATCH GT "Great & Tough" Excellent tracking Low record wear High output 8.0mV Spherical stylus for reverse tracking (DJ) Code OCOMGT</p>   <p>ORIGINAL GT STYLUS Code OSGT</p> <p>www.ortofon.com</p>	<p>CERAMIC CARTRIDGE</p> <p>Metal Clip Base Stereo Ceramic Code PC24</p>  <p>REPLACEMENT STYLUS D325</p>
<p>ORTOFON OM-20 CARTRIDGE</p> <p>OMB10 ELLIPTICAL STYLUS Thorens®, Rega-Planar®, etc. Elliptical 20Hz-27KHz 4.0mV Separation 30dB(1kHz) Balance 1.5dB Tracking 1.25 - 1.75g Weight 5.0g Code OMB10</p>   <p>REPLACEMENT STYLUS Stanfield D1229E</p> <p>Original Stylus Not Available www.ortofon.com</p>	<p>CERAMIC CARTRIDGE</p> <p>Screw down base Stereo Ceramic Code PC23</p>  <p>REPLACEMENT STYLUS D325</p>
<p>ORTOFON OM-10 CARTRIDGE</p> <p>WITH OMB5 CONICAL STYLUS <i>Super Optimum Match</i> Magnetic Cartridges. Premium grade stylus from the leader in European pick-ups. Code OMB5</p>   <p>REPLACEMENT STYLUS Stanfield D1229E</p> <p>Original Stylus Not Available Because same price as whole unit www.ortofon.com</p>	<p>BSR CERAMIC CARTRIDGE</p> <p>WITH MOUNTING ADAPTOR Ceramic pickup w/ diamond BSR SR78, ST16, 17, etc. Single screw hold type Plus an adaptor for Garrard 301, etc. Code PC05</p>   <p>REPLACEMENT STYLUS D475</p>
<p>TOSHIBA MAGNETIC N51M</p> <p>Replacement Diamond Stylus and Cartridge as used in many, many turntable assemblies. standard Screw-in type. Suit a majority of Asian turntables. Moving Magnet [MM] Code PC40</p>  <p>REPLACEMENT STYLUS D1190</p>	<p>CERAMIC CARTRIDGE MODERN</p> <p>POPULAR ECONOMY Widely used stylus Snap-fit type base Removeable coupling Code PC30</p>  <p>REPLACEMENT STYLUS Stanfield D1262</p>

STANFIELD

RECORD BRUSH - ANTISTATIC

Carbon fibre brush
reduces static
as it cleans.
Code PCT104



CARTRIDGE HEAD SHELL

Light weight Aluminium Four Pin
Bayonet arm attachment which is
standard on most tone arms.
eg. Thorens, Technics 1200, etc.
Accepts any standard cartridge.
eg. OM10, PC40, V15, EP-DJ, etc.
Includes four connection Leads.
Black in colour. Gold contacts.
Code CH10



RECORD WASH - ANTISTATIC

200ml Fluid Plus Cloth for Vinyl Records
Efficiently removes dust, dirt and static build up.
Non abrasive for gentle and effective vinyl cleaning.
www.am-denmark.com
Code AM10101 *



REPLACEMENT CLOTH CLN1515

*Fluid is flammable goods so must transport by road

CARTRIDGE WIRES X4

Four colour coded
wires with spade
connectors.
25mm long.
Code PCT204



RECORD CLEAN - ANTISTATIC

ANTISTATIC HAND BRUSH
Anodised Aluminium Handle
Conductive felt type brush
Sponge filled for even pressure
Removes static build-up and
cleans out grit in one action.
30ml cleaner squeegee bottle
Code AM10104



*Fluid is flammable goods so must transport by road

CARTRIDGE MOUNTING BITS

SCREW PAIR
A pair of screws & nuts.
Code PCT202



WEIGHT / SPACER
Add 2.25g / 2.5mm to
modify stylus mounting.
Code PCT225



WATER LEVEL

Adjust your platter
and/or cartridge
for absolute flat
level performance.
Improves tracking.
Code PCT230



Complete Belt: Double this measurement
Broken Belt: This measurement is the belts LENGTH



Remember to allow for the old belt to have been stretched.
Beware: Our belts are sold as per DIAMETER not length.

ALIGNMENT PROTRACTOR

Adjust your stylus angle
and position for minimum
tracking error across the
whole record. Vital piece
of equipment for proper
setup of your turntable.
You will notice it in the
improved stereo imaging.
Code PCT210

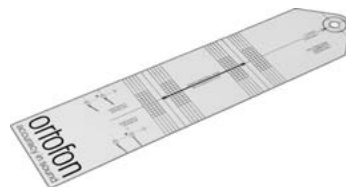

MECHANICALS GREASE

REPAIRERS & RESTORERS
Rebuilding an older
turntable mechanism
requires optimum
lubricants & Gease.
Get decades of service
using only the best.



POLYGLIDE CLEAR
Grease for plastics.
35g GR5147

MOLYKOTE WHITE
Surfaces & Bearings.
50g MK6195

MoS2 LM47 GREY
Metal bearings, etc.
100g GR3510

MORE SERVICE TOOLS
See WES Catalogue
Tools Section 14...



STYLUS GAUGE

OEM ORTOFON
Adjusts stylus weight
precisely and easily.

Dial is In Newtons.
[10x mN to the gram]
ie. 1g = 10mN

Code PCT220



STANFIELD



TURNTABLISTS

STEREO AUDIO TO OPTICAL/COAX

Analogue To Digital
Converts Stereo AUDIO IN to 16 bit PCM (Digital) output to Toslink Optical and RCA PCM connections. This digital audio stream is compatible with all of today's digital home-theatre amplifiers and receivers. Power pack inc'. No leads.



Code ADV2000

MINI-STEREO DJ MIXER

5 INPUT STEREO MULTIMEDIA MIXER DUB AUDIO FOR VIDEO OR DJ - 12V PORTABLE

This quality built mini sized audio mixer is comprehensive enough for many DJ applications. Excellent solution for audio dubbing in home movies or simple home studios. Turn a normal home amplifier into a Karaoke fun-for-all! Compact metal box. Low noise design. 12Vdc and small in size for portability and for minimum foot-print in a portable desk top mixer installation. 6.35mm headphone socket with volume Headphone monitors main output only Stereo LED VU meter for main output Microphone talk over mute switch Cross fader between channel A and B Hi gain output suits most amplifiers Desk standing or console mountable Stereo / mono selector switch 330(L) x 122(W) x 39(H)mm Includes 250Vac-12Vdc plugpack **Output** RCA Stereo 1.5V/600ohm **Microphone & Headphone** **Phono** (Ch1- Ch2) **CD/Line** (Ch1- Ch3)



Code RYM600

PHONO INPUT PREAMP

RIAA EQ FOR AUX IN

Minature Active Add-On Phono pre-amplifier RIAA Stand alone 70x40x120mm Metal Box. Screw mounts. Magnetic cartridge in Line level output. Suit upgrading modern home theater receivers that dont offer an input for your beloved turntable! Very easy solution. All metal construction. Gold plated terminals. Quality OpAmp circuit. Low noise design. 12Vdc. With powerpack.

Converts an AUXILIARY input On new modern theatre amps to accept a turntable input. Powered RIAA Pre-Amp. Screw to the back of your Turntable. 240Vac powered.



Code SP24A

PROFESSIONAL DJ MIXING DESK

5-INPUT MOBILE OR VENUE DJ MIXER INDEPENDENT HEADPHONE MONITOR TYPE

Designed for DJ use, this stereo mixer features a removable cross-fade slide control, LED VU meters, dedicated gain controls for each channel (including the master output) and cue level and mixing controls. A talk over function is also included and the channel to be cued can be selected with a centrally located rotary switch. The mixer accepts both phono and line level inputs and features line level outputs for recording to a DAT or tape deck, etc. Mono or stereo sources can be accommodated with a front panel located push button switch.

Mic 1.5mV/2k Ohm
Phono 3mV/47K Ohm
Line In 150mV/27K Ohm
F 20-20kHz +/- 2dB
THD 0.02%
S/N Better than 80dB
Size 254x191x100mm
Weight 2.2kg
Power 240VAC Mains



Code DX2600



PHONO INPUT CONVERTER

Run out of inputs ?

If you require an extra input to your amplifier here is an option to use that old phono input !



Your turntable is gathering dust, so why not use its' input for that new black box. Fully shielded in a metal box, premium quality components, gold plated plugs and sockets.

The circuitry re-equalizes the signal to counteract the RIAA eq. low level (MM) input. Passive (No power required). Small 75x25x55mm





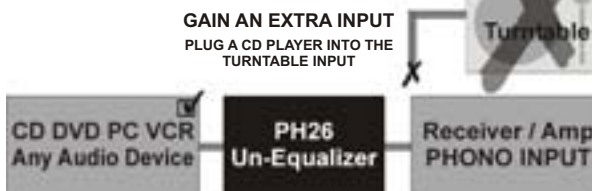



Code PH26



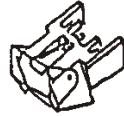

QUICK REFERENCE STYLUS LISTING

CODE	COPY OF STYLUS		
D35	VACO ST100 used by BSR and HMV.		
D87	HMV HV22D, 34D and PHILIPS AG3310.		
D88	BSR ST3, ST4 used by AWA, HITACHI, HMV, KRIESLER, PYE, SANYO		
D163	NEC LP25, CEC STY333, ONKYO DN8ST/ST, SANYO ST6D		
D164	SANYO ST14D used by AUDIO REFLEX, AWA, HITACHI, HMV, PYE, etc.		
D166	AWA N3DB, TOSHIBA N3CB/DB		
D170	KRIESLER S70SR, EEI, EXCEL S70SR		
D171	EXCEL S70HR widely used by many manufacturers.		
D184	AKAI MC9, JELCO ND9, SANSUI SN26 and SANYO ST15GD.		
D186	SHURE N91ED used by AKAI, DUAL, SANYO and others.		
D186ED	Elliptical version of above.		
D190	PIONEER PN11.		
D194	SANYO STG1 and TOSHIBA N3CD.		
D197	AUDIO TECHNICA ATS10, used by AKAI, AWA, HITACHI, HMV, PYE, SANYO,		
D325	VACO ST7, used by AWA, AWA, AUDIO REFLEX, COLUMBIA, HANIMEX, HITACHI, HMV, NATIONAL, ONKYO, PYE, RANK, SANYO, SHARP, SILVER, SONY, THORN. HMV HV17D, SONOTONE 9TA		
D332	SHURE N44-7 used by DUAL, KRIESLER and others.		
D387	BSR ST10, used by HMV, KRIESLER, PYE and others.		
D404	SHURE N75-6, used by DUAL, GARRARD, HMV, PYE, SANYO & YAMAHA		
D414	SHURE N44C, HEALING TM20		
D424	SHURE N55E, used by linear design & many others. (Elliptical)		
D425E	BSR ST12, ST14, used by EXPO, HMV, KRIESLER, PEY, RAMBLER, etc.		
D442	SONOTONE 3509, used by G.E., GARRARD, HMV, KRIESLER, RAMBLER, etc.		
D444	BSR ST16, ST17, used by AUDIO REFLEX, AWA, EXPO, G.E., HANIMEX		
D475	KRIESLER, NOVATECH, PYE, RANK, RAMBLER and SILVER. JVC DT29, used by AUDIO REFLEX, PHILIPS, PYE and RANK.		
D505	JVC DT33H		
D506	AUDIO TECHNICA AT55, AWA N13C, TOSHIBA N13C, YAMAHA N5500		
D508	AIWA AN8743, KENWOOD N43, SHARP STY705		
D524	PIONEER PN12 and PN10.		
D528	SONY ND108G, used in HITACHI and others.		
D539	ADC RK8, used by BSR and others.		
D558	SONY ND134G		
D563	SANSUI SN28, used by AUDIO REFLEX, SHARP and SILVER.		
D564	SANYO/FISHER ST28		
D565	NEC LP8300, CEC MC20, Harksound		
D569	KRIESLER / NATIONAL EPS13TT		
D570	SANSUI SN37.		
D574	SANYO ST27D, used by KRIESLER, TEAC, THORN and others.		
D579	ONKYO DN29ST, used by RANK, SHARP, SILVER, TEAC and TOSHIBA.		
D592	PIONEER PN135.		
D593	TOSHIBA NN1C, used by RANK ARENA and others.		
D594	SHURE N95ED, used by AWA, DUAL and others. (Elliptical)		
D606ED	AUDIO TECHNICA ATN71, used by AWA, COLUMBIA, HITACHI, G.E.,		
D608	KENWOOD, MARANTZ, NATIONAL, ONKYO, PYE, RANK, SANYO, TEAC and TOSHIBA. NATIONAL EPS270DD. Elliptical version of above.		
D616	KENWOOD N49		
D616ED	COLUMBIA DSN45, used by AWA, HITACHI, JVC, KRIESLER, PYE, SANYO.		
D1015	CEC / ORTOFON NF15E MK-II		
D1022	PIEZO AN122, used by AWA, COLUMBIA, THORN and others.		
D1029E	TOSHIBA N40G, used by SANYO, RANK and others.		
D1032	JVC DT36, used by AWA, RANK, SANYO, SILVER and TOSHIBA.		
D1022	AUDIO TECHNICA ATN3400, INKEL, LUXMAN, MARANTZ CT6, SANYO ST38		
D1060	AUDIO TECHNICA ATN3400, used by AKAI, AWA, HITACHI, JVC,		
D1070	KENWOOD, MARANTZ, MITSUBISHI, NATIONAL, ONKYO, SANSUI, SHARP		
D1071	CEC MC17, TEAC MC17		
D1081	AUDIO TECHNICA ATN3711, used by AWA, AKAI and others.		
D1085	PIEZO AN124, used by AWA, COLUMBIA and others.		
D1086	AUDIO TECHNICA ATN3401, used by SANYO, SHARP and YAMAHA.		
D1071	AIWA LM20, MITSUBISHI 3D-MM, ORTOFON/CONCORDE 20, Elliptical		
D1229	ADC QLM33-III, used by AUDIO REFLEX, BSR, HANIMEX and others		
D1093	SHURE N17C		
D1095	BSR T20MD, NOVATEC T-2MS, EXPO T20MD, MORSE T2MS, T20MI...		
D1109	PIONEER PN220.		
D1128	NATIONAL EPS25CS.		
D1129	BSR T2MS and TETRAD T2MS.		
D1132	ONKYO DN51ST, TOSHIBA N160C		
D1135	CEC 6-2188-1A, PYE MC6, TOSHIBA N20G.		
D1138	AIWA AN36, GENERAL MST6, G.E. / SANYO STG2,		
D505	MITSUBISHI 3D48M, ONKYO DN7, NEC LP60, SHARP STY117		
D1151	THORN / TOSHIBA N320C		
D1152	SHURE SS35C		
D1153	NATIONAL / THORN EPS41ST, DORCHESTER		
D1155	AUDIO TECHNICA ATN3601, used by AKAI, DUAL, JVC, PIONEER, ONKYO, SHARP, SONY, TEAC and YAMAHA...		
D1163	NATIONAL EPS24CS		
D1155	AUDIO TECHNICA ATN3600L, used by MORSE, NOVATEC, NATIONAL,		
D1174	PHILIPS D397-III, TOSHIBA N290S, NOVATEC, NAGAOKA JN711		
D1177	AUDIO TECHNICA ATN3472P, used by AKAI, CEC, DUAL, HITACHI, KENWOOD, JVC, MARANTZ, NATIONAL, PIONEER, SANSUI, SANYO, SHARP & SONY..		
D1179	SANSUI SN80, used by TEAC and others.		
D1181	AKAI RS50, MARANTZ CT243, SHARP STY129 STY133		
D1184	SHARP ST20D, used by MARANTZ, TOSHIBA and others.		
D1187	SANSUI SN303, used by AWA, AKAI, MARANTZ and MITSUBISHI.		
D1190	COLUMBIA DSN67, SANYO ST29 ST55 ST57, SHARP STY55, TOSHIBA.		
D616	NAGAOKA NM321B, used by AWA, KRIESLER, PHILIPS and PYE.		
D1243	SANYO STG9, used by AWA, HITACHI, THORN and others.		
D1163	MARANTZ CTN153, NATIONAL EPS30CS EPS33CS		
D1222E	Elliptical version of above. NATIONAL EPS30ES EPS33ES		
D1224	TEAC / SANSUI SN60, also suit MORSE, NOVATEC, TENSAL, SHERWOOD.		
D1229E	ORTOFON LM5, used by AWA, AKAI and others. (Elliptical)		
D1241	SANYO ST66D		
D1243	SANYO STG10, used by JVC, SHARP, TOSHIBA and others.		
D1260	SHARP STY146, used by CEC, SANYO, SONY, TOSHIBA and others.		
D1262	PYE / CEC CZ800-1 MZ8D, SANYO ST-05		
D1286	ADC SX-5, PYE HF1155		
D1289	STANTON D5107AL		
D1299	CEC BD95, TEAC P75, SHARP, MARANTZ, SANYO		
D1304	SHARP STY155		
D1307	ONKYO, TEMPEST, NOVATEC		
D1308	AKAI APM75, 393, Kenwood N777		
D6220	JVC DT-Z1S.		
D6290	NATIONAL EPS36.		
D6750	HITACHI ST103, PIEZO YM308		
D6890	SHURE N70B, N72B, widely used by many suppliers.		
D6890E	SHURE N70EJ, N72EJ, upgrade of D6890, (Elliptical version)		
D7390	PIONEER PN110-II		
D7480	SANSUI SN44		

CANT FIND IT? TRY REPLACING THE WHOLE CARTRIDGE!
 SEE PREVIOUS PAGES FOR DETAILS.

NUMERICAL INDEX

STYLUS#	BRAND & MODEL #	CODE	STYLUS#	BRAND & MODEL #	CODE	STYLUS#	BRAND & MODEL #	CODE
1	Steel Needles	I	130DJ	Goldring G820DJ	J	286	Philips AG3201	C
6	Knee Bent	C	130E	Goldring G820E	J	288	Seeburg 1000	J
8	BSR TC 2, 4	C	130SE	Goldring G820SE	J	290	Sonotone 16T	I
16	Acos GP37	C	140E	Goldring G900E	J	295	Sonotone 18T	C
17	Collaro O,P,T	C	156	Decca DERAM	J	296	Astatic 133	C
18	Garrard GC2	C	157	National EPS 46	I	298	Electro Voice EV2616	C
19	General Electric	C	158	National EPS 52	I	303	Lesla U2	C
22	Decca XMS	C	159	Sansui SN 31	I	309	Bang Olufson SP1,2	I
24	Acos GP19	C	160	Sharp ND15D	I	311	RCA 110.023	C
25	Acos GP59	C	161	Onkyo DN 22	I	313	PE 188	C
26	Collaro PX	C	162	Kenwood N35	I	315	Electro Voice EV132	C
30	Philips AG3012	C	163	Onkyo DN 8, 9	I	316	Dual DN4	C
31	Acos GP61	C	164	Toshiba N14C	I	318	Zenith 142/127	C
32	Dual DN2	C	165	Audio Technica	I	320	Vaco-Lux	C
33	Sonotone 2T	C	166	Toshiba N3CB	C	325	Shure N77	I
34	Telefunken TTSA	C	167	Sanyo ST5D	I	326	Sonotone 9TAHC	C
35	Acos GP83	C	170	Excel ES70S	I	328	Astatic 13TX	C
36	Acos GP65	C	171	Excel ES70HR	I	329	Elac SNM402	C
37	Schumann Mer. SK451	C	172	Excel ES70FR	I	330	Sonotone 9TA	C
39	Garrard GC8	C	173E	Excel ES70E	J	332	Elac SNM107	C
42	Collaro TX88	C	174EX	Excel ES70EX	J	334	Dual DN93	I
44	Ronette BF40	C	175	Columbia DSN16	F	335	Gen. Electric GC200	C
46	Acos GP71/3	C	176	Sanyo ST10D	F	336	Electro Voice EC2626	C
47	Garrard GCS10	C	177	National EPS14	F	337	EV2620,2622	C
48	Acos GP73	C	178	National EPS19	F	338	Sontone 21T	C
49	ERS 60	C	179	Sharp STY450	F	342	Zenith 142-136	C
51	Philips GP316	C	180	Toshiba N12C	I	343	General Electric C500	C
52	Philips AG3060,3063	C	181	Onkyo DN16	I	344	Schumann M. STK495	C
55	Power Point No.51	I	182	Onkyo DN18	I	345	Schumann M. STK481	C
56	Power Point No.56	I	183	Toshiba N300	I	346	Audio Empire S108-7	I
57	Schumann M. STK490	C	184	Sanyo ST15D	I	353	Euphonics U10	C
58	Elac SMN 9	C	185	ADC R660	I	355	Astatic N70	C
59	Elac SMN11	C	186	Shure N91GD	I	357	Astatic N56	C
60	Goldring CS60	C	186-3	Shure N91GD-78rpm	J	360	Philips GP3310	C
61	Goldring SX10	C	186ED	Shure N91ED	J	365	RCA 110.220	C
63	Dual DN3	C	187	Pickering D-AC3, AM3	I	366	Sonotone 25T	C
64	Garrard GC12	C	187E	Pickering D-ACE3	J	369	Lesla W	C
65	Collaro C	C	188	Stanton 500A	I	373	Tetrad No.32	C
69	Telefunken A10	C	188E	Stanton 500E	J	375	Tetrad No.33	C
70	Philips AG3066	C	189	Stanton 681A	I	376	Vaco CN60	C
71	Philips AG3301	C	189E	Stanton 681E	J	383	Shure N44-7	I
72	Teppaz ECO060	C	190	Pioneer PN10	I	387	Shure N44-3 (78 rpm)	J
73	Teppaz Stereo	C	192	Pioneer PN20	I	387-3	General Electric C650	C
74	Electro Voice EV21	C	193	Pioneer PN35	I	395	Philips AG3404	I
75	Philips AG3001	C	194	Sanyo STG1	F	396	Mastercraft	C
76	Reuter S1	C	195	Sanyo ST8D	I	400	Teppaz ECO 60/432	C
78	Elac SNM106	C	196	CEC MC7	I	402	BSR ST8,9	C
81	Goldring CS80	C	197	Audio Technica VM8-7	I	403/78	BSR ST10	C
82	Sonotone 8TA	C	198	Audio Technica AT21-5	I	404	National EPS05	C
84	ER5MB	C	200	Sansui SN23	I	407	Philips AG3311	C
85	ER5SB	C	201QD	Excel S70X4	L	408	ER Combact	C
86	Philips AG3310,3400	C	202	PE 5	C	411	ER 2 SX	C
87	Philips AG3306	C	203	PE 12	C	413	Shure N75-6	I
88	BSR ST4	C	204	PE 7000	C	414	Shure N75-3 78rpm	J
88/78	BSR ST4 78 rpm	C	208	Shure A53	C	414-3	Ronette TA60	C
89	Acos GP79, 80	C	212	General Electric VR114	C	416	PE192	C
90	Goldring CS90	C	216	Dual DN1	C	418	PE223	C
91	ER5MX	C	224	Pickering R150	C	419	Sonotone 23T	C
94E	Goldring CS91E	C	227	T Holder	C	423	Shure N44C	I
96	Dual DN5	C	233	Elac SNM101	C	424	Shure N55E	J
97	Acos GP91	C	234	Elac SNM100	C	425E	ADC 770	I
99	Pickering D380	I	235	Elac SNM103	C	426	Audio Empire S999	J
100	Pickering D AT	I	236	PE 182	C	427E	Audio Empire S888	I
100E	Pickering D ATE	J	237	Elac SNM14	C	428	Garrard GCM21,22	C
102	Pickering D AC	I	258	Tannoy Mk.II	C	430	Garrard GCS23	C
103	Pickering D AM	I	262	General Electric GC2	C	431	Garrard GCS25T	C
110	Goldring G800	I	263	Sonotone 9T	C	434	Garrard GCS25T	C
110DJ	Goldring G800DJ	J	267	Telefunken A200	C	436	BSR ST12	C
110E	Goldring G800E	J	268	Vaco ST45	C	442	BSR ST 12 78 rpm	C
110SE	Goldring G800SE	J	269	Shure N7D	I	442/78	Acos GP104	C
120	Goldring G850	I	270	Schumann M. SK456	C	443		
130	Goldring G820	I	279	General Electric VR22	C			

NUMERICAL INDEX

STYLUS#	BRAND & MODEL #	CODE	STYLUS#	BRAND & MODEL #	CODE	STYLUS#	BRAND & MODEL #	CODE
444	Garrard KS40A	C	532E	Shure VN15E	J	6170	Nagaoka JN311, 411	I
444/78	Garrard KS40A 78 rpm	C	533	CEC MC5	I	6180	Nagaoka JN511	I
445	Garrard GCS35	C	534	JVC DT32	I	6190	Nagaoka JN322	I
446	Garrard GDS2	C	535QD	National EPS451	L	6200	Supraphone VK4302	C
447	Sonotone 21T	C	536	Onkyo DN21	I	6210E	Goldring G900E	J
449	Conver COSMO	C	538	Onkyo DN27	I	6220	JVC DTZ1S	I
450	Toshiba N3CB	C	539	Sony ND108G	I	6230E	National EPS205E	J
452	Schumann M. STC485	C	540QD	Sharp STY751	L	6240	Sony ND100G	I
454	Shure N75G	I	541E	Shure VN35E	J	6250	Kenwood N46	I
455	Coner	C	542E	Shure N93E	J	6260	Kenwood N47	I
456E	Shure N75E/II	J	543	JVC DT33S	I	6270	Acos M6	I
457	PE190	C	545	Mitsubishi 3D-34M	I	6280	Kenwood N48	I
459	Toshiba NN1C	C	548QD	JVC DT1X, 10X	L	6290	National EPS36	F
461	Ronette SC107	C	549QD	Sharp STY751	L	6300	CEC MC11	I
464	Tetrad C2	C	550QD	Sony ND132G	L	6320	Jelco ND5	I
466	ADC 20	I	551	Sony ND132G	I	6330	Jelco ND12	I
469	Elac D144-17,244-17	I	552	Yamaha N4500	I	6340	Jelco ND14	I
470	Elac D344-17	I	553	Sony ND114P	I	6350	Jelco ND15	I
471	Elac D444-17	I	554QD	Pioneer PN21	L	6360	Micro V3300	I
472	Ronette CMT102	C	555QD	Sanyo ST45DX	L	6370	Piezo YM118	I
473	Lenco M94	I	556	Piezo YM114	I	6380	Sony ND15G	I
474	Dual DN 8	C	557	Sharp STY706	I	6390	Sony ND135G	I
475	BSR ST17	C	558	ADC RK8	I	6400QD	JVC 4DTZ1S	L
476	ERC900	C	559E	ADC RK8E	J	6410	Hitachi DS ST23	I
477	Teppaz MT30	C	561E	ADC RK3E, 5E	J	6420	CEC MC8	I
479	Acos GP104	C	563	Sony ND134G	I	6430	CEC MC10	I
481	BSR ST19	C	564	Sansui SN28	I	6440	Hitachi DSST5	I
483	Audio Tech. AT6-5D	I	565	Sanyo ST28D	I	6450	Kenwood N39/II	I
485	Columbia DSN16	C	566	Hitachi DSST101	I	6470	Philips GP215	J
486	Neat DS90	I	567QD	JVC 4DT5X	L	6480	Columbia DSN24	I
488	Astatic N63	C	568	Hitachi DSST20	F	6490	Sharp STY701	I
489	Astatic N72	C	569	CEC MC14, 20	I	6500	Sharp STY750	I
490	Asltatic N89	C	570	National EPS13TT	F	6510	Sharp STY102	I
491	Sony ND121P	I	572	Sansui SN27	I	6520	Sharp STY101	I
492	Sony ND125P	I	573	Sansui SN34	I	6610E	Stanton 681E, EE, EEE	J
493	Sony ND125G	I	574	Sansui SN37	I	6660	Shure N 75-6/II	I
494	Philips GP212	C	575QD	Sharp STY555QD	L	6690	Sansui SN50	I
495	Philips GP400	I	576	Micro V3200	I	6700E	Ortofon D20E/II	J
496	Philips GP205	C	577	Sanyo ST25D	I	6710E	Ortofon N15E	J
497	Philips GP370	I	578	Sanyo ST26D	I	6750	Hitachi DSST103	I
498	Shure N75C	I	579	Sanyo ST27D	I	6770	Sharp STY107	I
499	BSR ST20,21D	C	580	Sanyo ST35D	I	6780	Sharp STY105	I
501	Micro V 2100	I	581	Sony ND128P	F	6790	Sanyo ST15LD	I
502	Micro V3100	I	582QD	Hitachi F11	L	6800	JVC DT50	I
503	Coner	C	583QD	JVC 4DT20X	L	6810	ADC RXL, RVL, RSX	I
504	JVC DT27	I	584E	Audio Technica ATN12X	J	6820E	Audio Technica ATN13	J
505	JVC DT29	I	585	ADC RP30	I	6830	Audio Technica ATN15	J
506	JVC DT33	I	586	ADC RQ32	I	6870	Vernitron V100, 101	I
507	Toshiba N301	I	587	ADC RQ36	I	6890	Shure N70B	I
508	Audio Technica AT55	I	591	National EPS08	I	6890E	Shure N70EJ	J
509	Sony ND120P	I	592	Onkyo DN29	I	6910	Mitsubishi 3D-33, 48M	I
510	Sony ND113P	I	593	Pioneer PN135	I	6920	Mitsubishi 3D-23M	I
511	Sony ND127	I	594	Toshiba N11C	I	6930	Mitsubishi 3D-37M	I
512	Sansui SN25	I	595E	Audio Empire S909X	J	6940	Mitsubishi 3D-38M	I
513	General Electric C660	C	596	JVC DT23	I	6950E	Pickering XV-15-1200E	J
514	Lenco M150	I	598	Sony ND117G	I	7010	Mitsubishi 3D-23M	I
515	National EPS08, 10	I	600	Sony ND125G	I	7030	Toshiba N55D	I
516	National EPS25	F	601	Sharp STY717	I	7040	Mitsubishi 3D-42M	I
517	National EPS24	I	602	Excel S700CR	I	7060	Sony ND50G	I
518	Kenwood N34	I	603E	Excel S700ER	J	7070	Columbia DSN37, 42	I
519E	Philips GP412E	J	604QD	Excel S700CR	L	7080	Columbia DSN14	I
520	Tertad No.51	C	605	Sharp STY703	I	7090	Columbia DSN9	I
521	Tetrad No. 53	C	606ED	Shure N95ED	J	7100	Columbia DSN5	I
522	Kenwood N38	I	607	Onkyo DN33	I	7110	Columbia DSN22	I
523	Kenwood N39	I	608	Audio Technica ATN71	I	7120	Columbia DSN25	I
524	Kenwood N43	I	608E	Audio Technica ATN71E	J	7150	JVC DT34	I
525QD	Audio Technica ATN125	L	609	Dual DN201	I	7160	JVC DT26	I
526	Sharp N17D	I	611	National EPS11	F	7170	JVC DTX1	I
527	Sansui SN10	I	613	National EPS18	F	7180	Hitachi DSST25	I
528	Pioneer PN12	I	614	National EPS28	I	7190	Kenwood N20	I
529	Pioneer PN30	I	615E	Audio Technica ATS11E	J	7210	Kenwood N30	I
530	ADC R220X	I	616	National EPS270D	I	7220	Kenwood N31	I
531	Pioneer PN50	I	616E	National EPS270ED	J	7230	Kenwood N36	I















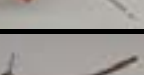
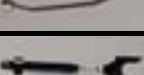
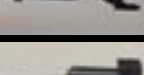

NUMERICAL INDEX

STYLUS#	BRAND & MODEL #	CODE	STYLUS#	BRAND & MODEL #	CODE	STYLUS#	BRAND & MODEL #	CODE
7240	Kenwood N37	I	1035	Piezo YM128	I	1117E	Audio Empire S2000E	J
7250	Mitsubishi 3D-29M	I	1036	Toshiba N270	I	1118E	Audio Empire S2000E/I	J
7260	Mitsubishi 3D-30M	I	1037	Pioneer PN200, 400	J	1119E	Audio Empire S2000E/II	J
7270	Mitsubishi 3D-31M	I	1038	Pioneer PN600, 800	J	1120E	Audio Empire S2000E/III	J
7280	National EPS56	I	1039HE	Shure VN45HE	L	1121E	Audio Empire S2000E/V	J
7290QD	National EPS440QD	L	1040E	Shure N75E/II	J	1122E	Audio Empire S2000Z	J
7300	National EPS205	I	1042E	Shure N99E	J	1123QD	Audio Empire S4000D/I	L
7310E	National EPS54STE	J	1046E	Sony ND35E	J	1124QD	Audio Empire S4000D/III	L
7320	Onkyo DN34	I	1047	Sony ND60G	I	1128	Audio Technica ATN70	J
7330	Elac D155-17	I	1048	Sanyo ST26J	I	1129	National EPS25CS	I
7340	Onkyo DN23	I	1049	Toshiba N500, 550/II	I	1131	Audio Technica AT-VM3	J
7350	Audio Technica ATS10	I	1051	Pioneer PN131	I	1132	Tetrad T2MD	C
7360	Pioneer PN14	I	1052	Sony ND150G	I	1133	Columbia DSN6	I
7370	Pioneer PN15	I	1054-3	Shure N70-3 (78 rpm)	J	1134	Columbia DSN41	I
7380	Pioneer PLN9	I	1055	Sanyo STG6	F	1135	Sharp STY116	I
7390	Pioneer PN110/II	I	1056	Kenwood N39/III	I	1136	Audio Technica ATN771	I
7400	Pioneer PN330	I	1057	Yamaha N6600	J	1137	Audio Technica ATN854	I
7410	Pioneer PN330/II	I	1058	Columbia DSN40	I	1138	Toshiba N20C	F
7420	Pioneer PN16	I	1059	Sony ND14G	I	1139	Kenwood N50	I
7440	Sansui SN29	I	1060	JVC DT36	I	1140	National EPS23CS	I
7450	Sansui SN41	I	1061	Audio Technica ATXN1	J	1141E	National EPS23CES	J
7470	Sansui SN42	I	1062E	Columbia DSN35, 36	J	1142E	Toshiba N550CEX	J
7480	Sansui SN48	I	1066	Yamaha N7000	J	1143	Sanyo ST107	I
7490	Sansui SN45	I	1067	Tectron N512S	I	1144	Toshiba N33C	I
7500	Sharp STY100	I	1068	ADC RSV	I	1145E	Dual DN145E, 150E	J
7530	Sanyo ST50D	I	1069	Onkyo DN39	I	1145	Dual DN140S	I
7540	Sanyo ST30D	I	1070	Audio Technica ATN3711	I	1146E	Dual DN149, 155E	J
7550E	Sony ND25E	J	1070E	Audio Tech. ATN3711E	J	1147E	Dual DN160E	J
7560	Sony ND115G	I	1071	Audio Technica ATN3400	I	1148	JVC DT37	J
7580	Yamaha N3500	I	1071E	Audio Tech. ATN3451E	J	1149E	Audio Empire S200E	J
7600	JVC DT25H	I	1072	Columbia DSN48	I	1150E	Audio Empire S300ME	J
7610	Pioneer PN11	I	1073	Dual DN211, 221, 236	I	1151	Nagaoka N320	I
7620QD	Sanyo ST44DX	L	1074	Micro V70	I	1152	Shure SS35C	I
7630	Sony ND133G	I	1075	Sony ND137G	J	1153	National EPS41	I
7640	Akai RS100	I	1076E	Audio Technica ATXN3E	J	1154	National EPS37	I
7650	Sanyo ST17D	I	1077E	Audio Technica ATN71E	J	1155	Audio Technica ATN3601	J
7660	Sanyo ST20D	I	1078	Tectron N812S	I	1155E	Audio Tech. ATN3651E	K
7720	Elac D355-17	I	1079HE	Shure N95HE	K	1156	Seeburg Showcase	I
7720E	Elac D355E	J	1081	CEC MC17	I	1157	JVC DT41	I
7730	Sansui SN47	I	1082	Sony ND220G	I	1158	Audio Empire S100S	I
7760	Hitachi DSST24	I	1083E	National EPS207ED	J	1159	Columbia DSN51	I
1001	Acos M7	I	1084	ADC QLM30/II	I	1160	Columbia DSN55	I
1002	Piezo YM305	J	1085	Akai RS95	I	1161	Toshiba N310C	I
1003	Columbia DSN32	I	1086	Piezo YM123	I	1162	Columbia DSN60	I
1004E	Hitachi DSST104	J	1087	Pioneer PNK85	I	1163	National EPS24CS	I
1005	Elac D144-17	I	1088E	Pickering D3000E	J	1164E	Yamaha N8000	J
1006E	Elac D255E	J	1089	Toshiba N60DY	I	1165E	Audio Technica ATN31E	J
1007E	Elac D555E	J	1090	Audio Technica ATN3401	I	1166	Sanyo ST20J	I
1008	Elac D455-12	I	1091	Sony ND200	I	1167	Audio Tech. ATN3600L	J
1009E	Elac D455E	J	1092E	Mitsubishi 3D-MM1	J	1168	Audio Tech. ATN3820	J
1010	Toshiba N58	I	1093	ADC QLM30/III	I	1169	CEC MC45	J
1011	Elac D555-12	I	1094E	ADC QLM32/III	J	1170	Excel S65	I
1012QD	Kenwood N40	L	1095	Shure N17CM	I	1171E	Stanton D600E	J
1014	Sonic Star S10C	I	1096	CEC MM1	I	1172	CEC MM3	I
1015	Kenwood N49	I	1097	Hitachi DSST15	I	1173	Audio Technica ATN105	J
1016	Lenco VM95P	I	1098E	ADC QLM36/III	J	1174	Toshiba N290D	I
1018	Micro V7000	I	1099QD	ADC RZL	L	1175	Audio Technica ATN51	J
1019	Sanyo ST10J	I	1100	Tectron N712S	I	1176	JVC DTZL1S	I
1020	Nagaoka NM11A	I	1101	Onkyo DN38	J	1177	Audio Tech. ATN3472P	J
1021	Nagaoka NM22	I	1102E	Ortofon D20E Super	J	1177E	Audio Tech. ATN3472E	K
1022	Columbia DSN45A	F	1103	Pioneer PN150	I	1178	Pioneer PNK65	I
1023	Ortofon N15S	I	1104E	Pioneer PN550/II, 1000/II	J	1179	Sansui SN80	I
1024E	Ortofon NF15E	J	1105QD	Pioneer PNQ1	L	1180	Sanyo ST101D	J
1025	Ortofon NF15X/II	I	1106QD	Stanton D81S	L	1181	Sharp STY129	J
1026E	Ortofon NF15XE/II	J	1108E	Pioneer PN550E	J	1182	Sony ND143G	J
1027	Ortofon NF15/II	I	1109	Tetrad T20MD	C	1183	Toshiba N62	I
1028E	Ortofon NF15E/II	J	1110	Sanyo ST100D	J	1184	Sharp STY127	I
1029	Ortofon NF15.O/II	I	1111	Ortofon D20	I	1185	Sanyo ST37D	I
1029E	Ortofon NF15EO/II	J	1112	National EPS27	I	1186	Audio Technica ATN892	I
1030	Philips D412	I	1113E	National EPS202ED	J	1187	Audio Technica ATN3851	J
1031E	Philips D401E	J	1114	Sharp STY121	I	1188	Hitachi DS ST55	I
1032	Columbia DSN37	I	1115E	ADC RSQ34	J	1189	Onkyo DN57ST	I
1033	Pickering 380	I						









NUMERICAL INDEX

STYLUS#	BRAND & MODEL #	CODE	STYLUS#	BRAND & MODEL #	CODE	STYLUS#	BRAND & MODEL #	CODE
1190	Toshiba N50, 51M	I	1273	Sony ND300G	I			
1191	Audio Technica ATN102P	J	1274	Sony ST08	I			
1192	Sharp STY128	I	1275HE	Shure N97HE	L			
1193	Tetrad T30MD	C	1276E	Dual DN380E	J			
1194	Tetrad T50MD	C	1277E	Dual DN390E	J			
1195E	Excel S6 5E	J	1278	Sanyo ST67D	I			
1196E	Audio Tech. ATN120E	J	1279	Sanyo STG13, 14	I			
1197	Nagaoka NM321B	I	1280	Aiwa AN2, 77	J			
1200MC	Audio Technica ATN30	L	1281	Sharp STY145	J			
1203	Marantz CTN520	J	1282	Toshiba N70	I			
1204	Sanyo ST15J	I	1283	Seeburg 1000	J			
1206E	Audio Tech. ATN110E	J	1286	ADC RPSX5	J			
1207E	Dual DN241	J	1287	Audio Empire S2 50	I			
1208	Sanyo STG9	I	1288	Kenwood N67	I			
1209	AIWA AN30	I	1289AL	Stanton D500AL	J			
1210	ADC QLM33/III	I	1289FLU	Stanton D500AL Fluores.	J			
1212E	Audio Technica ATN51E	J	1290	Sansui SNP212	I			
1213E	Columbia DSN61	J	1293	Onkyo DN56	I			
1214E	Columbia DSN62	J	1294	Sony ND250G	I			
1215	Excel S300CR, ESP300C	J	1295	Ortofon N5P	I			
1216E	Elac D792E	J	1296E	Ortofon N10PE	J			
1217	JVC DT12	I	1297	Sanyo ST102SD	I			
1218	Hitachi DSST70	I	1298	Audio Technica ATN361	I			
1219	Kenwood N54	I	1299	Sanyo ST09	I			
1220	Nagaoka N100MP	K	1300	Nagaoka N200MP	K			
1221	National EPS-P30CS	I	1301-3	Shure N75-3	J			
1222E	National EPS-P33ES	J	1302E	Audio Tech. ATN102EP	K			
1223	Philips GP400/III	I	1303PRO	Ortofon OM-PRO	J			
1224	Sansui SN60	I	1304	JVC DT55B	J			
1226	Audio Technica ATN727	J	1305E	Stanton D71E	J			
1227	Sansui SN707	J	1306	Sanyo STG11	I			
1228E	Sony ND50X	J	1307	Tempest TF3000, TEAC	I			
1229E	Ortofon OM5E, OMP5E	J	1308	Kenwood N77	J			
1229AL	Ortofon Disco Pro Fluor.	J	1309	Hitachi DSST8	I			
1229 PRO	Ortofon OM-PRO	J	1310	Excel S45	I			
1231	Philips GP330	I	1311	Micro V20	I			
1232	Sansui SN505	I	1312	Tenorel N2001	J			
1236	Nagaoka N10MP	K	1315	ADC RXMI	J			
1237E	Shure N92E	J	1316E	Audio Empire S400TC	K			
1238E	Shure N99E	J	1317E	Audio Empire S500ID	K			
1239MC	Audio Tech. ATN3230	L	1318LAC	Audio Empire S600LAC	L			
1240	Akai RS10	I	1321	Audio Technica ATN201	J			
1241	Sanyo ST66D	I	1322	Audio Technica ATPN1	J			
1242	Toshiba N75	I	1323E	Audio Technica ATPN2E	K			
1243	Sanyo STG10	I	1324E	Audio Technica ATPN3E	K			
1245	Pioneer PN290T	I	1325E	Elac D794E, 795E	J			
1246	Sharp STY144	J	1326	Mastercrart SMC101	I			
1247	ADC RL4	I	1327E	Ortofon D10E/II	J			
1248E	Shure N104E	J						
1249	ADC RQ3, 4	I						
1251E	Audio Tech. ATN115E	J						
1252	JVC DTZ5S	I						
1253	Marantz CT100	I						
1254	Sansui SN909	J						
1255	Seeburg V200	J						
1256	Kenwood N62	I						
1257	National EPS51CS	I						
1258	Toshiba N37D	I						
1259	Marantz CT551	I						
1260	Sharp STY146	I						
1261	Sanyo ST03	I						
1262	Philips CZ800/1	I						
1263	Sanyo ST07	I						
1264	Sanyo ST47	I						
1265	Columbia SJN68	I						
1266	Audio Empire S111	I						
1267	ADC RPSX10	I						
1268	Pioneer PN291, 301	J						
1269E	Audio Technica ATN14	J						
1270E	Audio Technica ATN15E	J						
1271	Sony MM1	I						
1272E	Sony MM2	J						



ACOS

Original Stylus Number	Original Cartridge Number	Cart-ridge Type	Stylus Tip	Tracking Force	Colour	Diagram	STYLUS		Price Code
							No.	or use:	
GP19 GP20 GP40	GP19	CE	LP		Metal		24		C
GP37,39	GP37	CE	LP		Metal		16		C
GP59	GP59	CE	LP		Metal		25		C
GP61	GP61	CE	LP		Metal		31		C
GP65,67	GP65,67	CE	LP		Metal		36		C
GP71/3		CE	SR		Metal		46		C
GP73	GP73	CE	SR/2		Yellow		48		C
GP79,80		CE	LP		Metal		89		C
GP83	GP83	CE	SR or 78rpm		Metal		35 35STD		C C
GP91-96	GP91	CE	SR/2 SR/78		Black Black		97/2 97/78		C C
GP104	GP104	CE	SR/2		Black		443	479	C
GP104 Single	GP104	CE	SR		White		479	443	C
M6	M6	MM	C	3.0g	White		6270		I
M7	M7	MM	C	2.0g	Red		1001		I
ADC									
R20	220	IM	C	1.5g	Red		466		I
R20X	220X	IM	C	2.0g	Beige		530		I
R660 R770	660 770	IM IM	C C	1.8g 1.5g	Grey Red		185 426		I I
RK8 RK8E	K8 K8E	IM IM	C E	0.75-1.5g 0.75-1.5g	Blue Blue		558 559E		I J
RL3,5 RL4	L3,5 L4	IM IM	C C	2.0g 1.5g	Blue Red		1247 1247		I I





ADC

Original Stylus Number	Original Cartridge Number	Cart-ridge Type	Stylus Tip	Tracking Force	Colour	Diagram	STYLUS		Price Code
							No.	or use:	
RP30, RQ30 RP32,34 RP36 RQ36	P30,Q30 Q32,34 Q36	IM IM IM	C E E	2.0g 1.5g 1.2g	LtBlue LtBlue LtBlue		585 586E 587E	558 559E 559E	I J J
RSX5	SX5	IM	C	1.25g	Black		1286		J
RPSX10 RPSX20 RPSX30 RPSX40	RSX10 RSX20 RSX30 RSX40	IM IM IM IM	C E E E	1.25g 1.25g 1.25g 1.25g	Blue Red White Black		1267 1267E 1267E 1267E		I J J J
RQ3 RQ4	Q3 Q4	IM IM	C C	2.0g 1.5g	Blue Red		1249 1249		I I
RQLM30 RQLM32,36	QLM30/II QLM32,36/II	IM IM	C E	1.5g 1.5g	Black Black		1084 6810E		I J
RSQ30,31,33 RSQ32,34 RSQ36 RZL RSX,RSL,RSZ RSV RVL	QLM30,33/III QLM32,34/III QLM36/III XLM/II XLM/III,ZLM XLM/III VLM	IM IM IM IM IM IM IM	C E E E E C E	4.0g 3.0g 1.2g 0.9g 0.9g 1.2g 1.5g	DkGrey DkGrey DkGrey Black Black Black Black		1093 1094E 1098E 6810E 6810E 1068 6810E		I J J J J I J
RSQ32 Impr RSQ34 Impr RSQ36 Impr	QLM32/III Im QLM34/III Im QLM36/III Im	IM IM IM	E E E	3.0g 2.0g 1.2g	DkGrey DkGrey DkGrey		1068E		J
RSX Improved RSZ Improved RXL Improved	XLM/III Impr ZLM Improve XLM/III Impr	IM IM IM	E E E	1.2g 0.9g 1.1g	Black Black Black		1315E		J

AIKO

ACD200, AHS129, 222, 242 AHS303, 8841	CE	C	4.0g	Red		1260		I
AHS303, 702	CE	C	6.5g	Red		1279		I

AIWA

24D	CX306, 308	CE	SR	6.0g	Metal		325		C
AN1A	AF5100	MM	C	2.0g	Red		1060		I
AN2		VM	C	2.0g	Black		1280		J
AN5		VM	C	2.5g	Red		1071	1090	I

AIWA

Original Stylus Number	Original Cartridge Number	Cart-ridge Type	Stylus Tip	Tracking Force	Colour	Diagram	STYLUS		Price Code
							No.	or use:	
AN6		MM	C	2.0g	TrGreen		616	158	I
AN7		VM	C	2.0g	Yellow		1070		I
AN10		MM	C	1.25g	Blue		1243	1208	I
AN F10		MM	C	2.0g	Blue		1258		I
AN11		VM	C	3.5g	Grey		1155	1167	J
AN20		MM	C	2.5g	Red		1208	1243	I
AN30		MM	C	2.0g	DkBlue		1209		I
AN35		MM	C	2.0g	Red		1060		I
AN36	ME36	MM	C	3.0g	Grey		1143	505	I
AN50		VM	C	2.0g	Black		1168		J
AN60	MG37	MM	C	1.5g	White		1185	1178	I
AN70		VM	C	1.5g	Black		1187		J
AN77D		VM	C	2.0g	Black		1280		J
AN4932	M32	MM	C	3.0g	LtGreen		534	6490	I
AN8743		MM	C	2.5g	Orange		524	578	I
AN8745		MM	C	2.5g	Red		7730	7480	I
N95ED	M95ED	MM	E	1.2g	Yellow		606ED		J
Stylus 5 E	LX10	MM	E	2.0g	Black		1229E		J

AIWA

Turntable/System No	Stylus No	Turntable/System No	Stylus No	Turntable/System No	Stylus No
AF5100	1060	LX10	1229E	PXE45,55,75, 77, 88,333	1155
AF5050, 5080	524	LX11	1187	PXE 550, 750,770,850, 855	1155
AP001, 002	197	LX15	1168	V200	1280
AP2060	524	LX20, 30	1280	V220	1208
AP2100, 2200, 2300, 2400	7730	LX50	1168	V300	1209
AP2500, 2600, 3000	606ED	LX55, 70	1187	V550	1155
AP5050, 5080, 5300	524	LX80	1280	V700	1187
APD30	7730 or 1071	LX100	1229E	V770	1155
APD33C	1070	LX120	1168	V800,850,990	1280
APD35	1143	LX700, 1100	1187	V1000,1100,1600	1187
APD50	1070 or 1185	M501	1070	V2100, 2200	1208
APD60	1185	Pro1011	1071	V3300,3400,4400,5500	1280
APD80, D50	1070	PSW6, 9	1208	V5700,7400,7500,7600	1280
APD120	1071	PX10	1243	V7700	1280
AQD8800	1093	PX30	1209	W7	1280
CX55	1168	PX220	1243	X33,55,78	1155
E10	1243	PX451	1155	X900	1168
E770	1155	PXE22	1280	XL8000	1280









AKAI

Original Stylus Number	Original Cartridge Number	Cart-ridge Type	Stylus Tip	Tracking Force	Colour	Diagram	STYLUS		Price Code
							No.	or use:	
APN2, 4, 5		VM	C	2.0g	Yellow		197		I
RS3J		IM	C	3.0g	Black		1224		I
RS4, 5	SMB5	MM	C	2.0g	Black		1229E		J
RS7	PC7	VM	C	1.3g	Grey		1191		J
RS10	PC10	IM	C	1.25g	Black		1240		I
RS12	SMB12	MM	E		Black		1229E		J
RS25	PC25	VM	C	2.5g	Grey		1090	1071	I
RS33, 35	PC33	VM	C	1.3g	Ivory		1177		J
RS38	YM121	MM	C	2.0g	Black		7480	7730	I
RS41		MM	E		Black		1229E		J
RS50		VM	C	2.0g	Black		1181		J
RS65		MM	C	2.0g	Black		1036		I
RS77		VM	C	1.5g	Black		1187		J

AKAI

Original Stylus Number	Original Cartridge	Cart-ridge	Stylus Tip	Tracking Force	Colour	Diagram	STYLUS		Price Code		
							No.	or use:			
RS82		VM		C	2.0g		Red	1155,1167	J		
RS83		VM	C	2.0g	Yellow or Red		1071	1090	I		
RS84		IM	C	1.5g	Red		1178		I		
RS85	PC85	VM	C	2.0g	Black		1090	1071	I		
RS90	PC90	VM	C	2.0g	Yellow		1070		I		
RS95	PC95	VM	E	2.0g	Green		1085E		J		
RS100, 120	PC100, 120	IM	C	2.5g	Black		6750		I		
RS150E	PC150	VM	E	1.5g	Black		584E		J		
RS180	PC180	VM	E	1.0g	Burgundy		1269E		J		
RS200	PC200	VM	E	1.7g	Black		1196E	1226	J		
Turntable/System No		Stylus No		Turntable/System No		Stylus No		Turntable/System No		Stylus No	
AC100C, 103C		6750		APD2, 3		1071		APQ310		1071	
AC206C, 306C		6750		APD30, 33, 40, 50		1070		APX1C		1177	
AC3750S, 3800		7480		APD88		1177		FD3		1071	
ACM37, 40, 345, 353		1308		APD120, 210, 310		1071		FD7, FP7		1178	
ACM58, 548		1260		APL45, 95		1070		Midi 1		1224	
ACM512		1177		APM3		1179		Midi 3		1179	
ACSM333		1260		APM5		1229E		Midi7		1240	
AP002D		414		APM6		1240		Pro20, 30		1070	
AP001C, 003, 004		197		APM7		1240		Pro110, PXE900		1155	
AP004A		186		APM10		1240		Pro400		1177	
AP005, 006, 007		197		APM11, 31, 33, 35		1177		Pro501, 504, 601		1070	
AP30		1070		APM37, 40, 50, 57, 70, 75		1308		ProA5, A7		1229E	
AP100, 101, 103, 206, 207		6750		APM77		1187		ProA100, 102, 200		1177	
AP306, 307		6750		APM111, 121CD, 222		1260		ProA201, 202, 300		1177	
AP420		197		APM232		608		ProA302, 400, 402		1177	
AP821		1090		APM293		1308		ProE10		6750	
AP5000		1299		APM300, 305, 310, 315		1177		ProE110		1071	
APA1		1177		APM333, 340		1260		ProE200		6750	
APA10		1240		APM350, 360, 370, 600		1155		ProE210		1071	
APA50, 100, 101, 102, 150		1177		APM345, 353, 373, 393, 430		1308		ProE300		6750	
APA200, 201, 301, 305		1177		APM459, 512		1177		ProE310		1071	
APA400, 510		1177		APM525CD, 636CD		1260		ProE400		6750	
APB1		1155		APM630, 640		1308		ProE510, 710		1229E	
APB10, 20		1070		APM659		1177		ProR1, 2, 3, 100		1071	
APB21		1071		APN2, APNQ4		6750		ProS11, 21, 22, 31, 32		1071	
APB30, 33, 40, 50		1070		APQ41		1229E		System5		1196E	
APB110, 210		1090		APQ50, 51, 55, 60		1070		SystemD50		1070	
APB310		1071		APQ70, 80		1229E		SystemM300, 305, 310		1177	
APD02		6750		APQ206		6750		SystemM313, 315		1177	

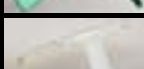

ASTATIC

Original Stylus Number	Original Cartridge Number	Cart-ridge Type	Stylus Tip	Tracking Force	Colour	Diagram	STYLUS		Price Code
							No.	or use:	
N7, 8, 70, 74 N76, 78, 320		CE	SR STD	6.0g	Metal		35		C
N13TX		CE	SR		Black		329		C
N15, 43	Rockola	CE	SR		Red		301		C
N51, 63	133, 135, 139	CE	SR/2		Black		488		C
N56	153	CE	SR/2		White		360		C
N60		CE	SR/2		White		357		C
N72	142, 496	CE	SR/2		Green		489		C
N89	201, 209	CE	SR/2		TrWhite		490		C
N133		CE	SR/2		Red		298		C

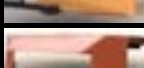
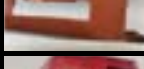
ARMSTRAD

Turntable/System No.	Cartr.	Tip	Track	Color	Diagram	Stylus No	or use:	Code
CD 1000, CDX 500	VM	E	1.7g	Caramel		1196E		J
CDX 400, MX 100, Studio 100	CE	C	4.0g	Red		1260		I
MX 300	MM	C	2.5g	Red		1190		I



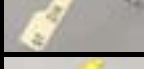









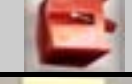

ASTOR

BGD 23, 24, 49	CE	SR/2	7.0g	White		404	403	C
G 14 Q, GDO 45, 46, 47, 48	CE	SR/2	3.5g	White		88/2	442	C
		SR/78	3.5g	White		88/78		C
GEO 50, 51, 59, 61, 62, 63 S 1000, 1200	CE	SR/2 SR/78	3.5g 3.5g	Yellow Yellow		464/2 464/78		C C

AUDIO EMPIRE

Original Stylus Number	Original Cartridge Number	Cart-ridge Type	Stylus Tip	Tracking Force	Colour	Diagram	STYLUS		Price Code
							No.	or use:	
S44E	44 E	IM	E	1.5g	TrGreen or TrSmoke		1150E	1149E	J
S66EX, X7RD	66X, 906	IM	C	2.0g	Red		1116		I
S100S	100S	IM	C	4.0g	TrYellow		1158		I
S108-7			C		White		353		I
S111	190LT	MM	C	1.25g	Clear		1266		I
S200E	200E 280LT	IM	E	2.2g	TrBlue		1149E		J
S300ME	300ME 380LT	IM	E	1.8g	TrSmoke		1150E	1149E	J
S333	290LT 390LT	MM	E	1.25g	TrBlue		1266E		J
S400TC S500ID S600LAC	400TC,480LT 500ID 600LAC	IM IM IM	E E LC	1.4g 1.1g 1.5g	TrRed Purple Black		1316E 1317E 1318LC		K K L
S808E	S999VE	IM	E		Purple		427E		J
S888	S888-7	IM	C	3.5g	Brown		428		I
S906	906	IM	C	1.8g	Black		1116		I
S909EX S999SEX S1000Z, ZEX	909EX 999EX, SEX 1000Z, ZEX	IM IM IM	E E E	2.5g 1.0g 1.0g	Black DkGrey Black		595E		J
S2000	2000	IM	C	2.2g	TrSmoke		1116		I
S2000E	2000E	IM	E	1.9g	TrRed		1117E		J
S2000E/I	2000E/I	IM	E	1.5g	TrGreen		1118E		J
S2000E/II	2000E/II	IM	E	1.2g	TrBlue		1119E		J
S2000E/III	2000E/III	IM	E	1.2g	Clear		1120E		J
S2000E/V	2000E/V	IM	E	1.2g	Silver		1121E		J
S2000Z	2000Z	IM	E	1.0g	Gold		1122E		J
S4000D/I	4000D/I	IM	SH	1.4g	Black		1123QD		L
SC1	150C, 250	MM	C	2.0g	Black		1287		I





















AUDIO REFLEX

Turntable or System Number	Cart-ridge Type	Stylus Tip	Tracking Force	Colour	Diagram	STYLUS		Price Code
						No.	or use:	
ARD 8200 LAB 200, 300, 550	VM	C	2.5g	Yellow		608		I
ARD 8800 LAB 100, 500, 600	IM	C	4.0g	DkGrey		1093		I
AT 110	CE	SR/2	4.5g	White		475	499	C
DD 1975	IM	E	1.9g	TrRed		1117E	1118E	J
DD 1975, MR 111	MM	C	3.0g	TrRed		505	1143	I
JB 2000	MM	C	2.0g	Black or Blue		1096		I
JB 5000	MM	C	2.5g	Red		1184		I
JH 300 MR 130, 140	CE	C	3.0g	Ivory		164	594	I
JH 300 M MR 130M, 140M	MM	C	2.0g	TrYellow		1067	1078	I
LAB 400, 450 PD 40, 604, 605 ST 901	VM	C	2.2g	Red		1071	1090	I
MR 110, 116	MM	C	3.0g	LtGreen		545		I
MR 120, 145B	MM	C	2.5g	Beige		564		I
MR 125	MM	C	3.0G	White		6270		I
PD 607	VM	C	1.5g	Black		1175		J
SHA 2, 2000	MM	C	1.2g	Black		1111		I

AUDIOSONIC

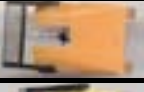
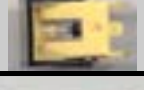
858-619 M 8005	CE	C	4.0g	Red		1260		I
993-663	CE	C	6.5g	Red		1279		I
1090 A, P 163 RP 30	CE	C	6.0g	Gold		325		C
CP 600 A	MM	C	2.0g	Red		1260		I

AUDIO TECHNICA









Original Stylus Number	Original Cartridge Number	Cart-ridge Type	Stylus Tip	Tracking Force	Colour	Diagram	STYLUS		Price Code
							No.	or use:	
AT3-5D, 7D	AT3	MM	C	2.0g	White		7190		I
AT4-7D	AT4	MM	C	2.5g	Red		492		I
AT6-5D, 7D	AT6	MM	C	3.5g	White		165		I
AT21-5	AT21	IM	C	1.3g	Yellow		180		I
AT55-7	AT55	IM	C	2.5g	White		508	493	I
AT66-7D	AT66	IM	C	3.0g	Grey		180		I
ATN12XE	AT12XE	VM	E	1.4g	Brown		584E		J
ATN12S	AT12SA	VM	SH	1.3g	White		583QD		L
ATN13Ea ATN14	AT13Ea AT14	VM VM	E E	1.3g 1.3g	Green or Orange Burgundy		6830E 1269E		J J
ATN15 ATN20	AT15SA,XE AT20SLa, SS	VM VM	E E	1.3g 1.3g	Black Black		1270E		J
ATN30, 31	AT30, 31	VC	C	1.7g	Black		1200MC		L
ATN51,52,53	AT51,52,53	VM	C	1.5g	Black		1175		J
ATN51-59E	AT51-59E	VM	E	1.5g	Black		1212E		K
ATN70,71,72 ATN70L	AT70,71,72 AT70L	VM VM	C C	2.5g 3.5g	Yellow Grey		608		I
ATN71E,72E	AT71E, 72E	VM	E	2.0g	Green		6820E		J
ATN90, 91 ATN94E	AT90, 91 AT94E	VM VM	C E	2.0g 2.0g	Yellow Green		1155 1155E		J K
ATN93	AT93	VM	C	2.0g	Yellow		1071		I
ATN95E	AT95E	VM	E	2.0g	Green		1071E		J
ATN101P ATN101EP	AT101P AT101EP	VM VM	C E	1.3g 1.3g	Yellow Green		1177 1177E		J K
ATN102P ATN102EP	AT102P AT102EP	VM VM	C E	1.3g 1.3g	Grey Green		1191 1302E		J K
ATN103 ATN120, 130E ATN135, 150E	AT103 AT120, 130E AT135, 150E	VM VM VM	C E E	2.0g 1.5g 1.3g	Red Caramel Blue		1226 1196E 1196E		J K K
ATN105 ATN110E,412E	AT105 AT110, 412E	VM VM	C E	2.0g 1.5g	Yellow Blue		1173 1206E		J K
ATN112, 122E KATN132, 152E	AT122,122EP AT132,152EP	VM VM	E E	1.3g 1.3g	Green Red		1302E 1302E		K K

AUDIO TECHNICA

Original Stylus Number	Original Cartridge Number	Cart-ridge Type	Stylus Tip	Tracking Force	Colour	Diagram	STYLUS		Price Code
							No.	or use:	
ATN201,211P ATN216,221 ATN231P,261	AT201,211P AT216,221P AT231LP,261	VM VM VM	C C C	1.3g 1.3g 1.5g	Grey Yellow Red		1321 1321 1321		J J J
ATN430E	AT430E	VM	E	1.3g	Red		1196E		J
ATN410E	AT410E	VM	E	1.3g	Green		1302E		J
ATN750	AT750	MM	C	2.0g	Red or Black		1096		I
ATN770, 771	AT770, 771	VM	C	2.5g	Yellow		608		I
ATN854	AT854	MM	C	1.5g	Black		1137		I
ATN892	AT892	MM	C	2.0g	Black		1186		I
ATN936	AT936	MM	C	2.5g	Orange		552		I
ATN952	AT952	MM	C	2.0g	Black or Orange		1015		I
ATN2001, 02 ATN2003, 04 ATN2005, 06	AT2001, 2002 AT2003, 2004 AT2005, 2006	VM VM VM	C C C	2.0g 2.0g 2.0g	Blue, Green or Red		1155 1155		J J
ATN3230	AT3230	VC	C	1.7g	Black		1239MC		L
ATN3400,01 ATN3410,50 ATN3450 ATN3451 ATN3451,52E	AT3400,01 AT3410,50 AT3450 AT3451 AT3451E,52E	VM VM VM VM VM	C C C C E	2.5g 2.2g 2.5g 2.0g 2.0g	Grey Red Grey Yellow Green	 	1090 1071 1090 1071 1071E		I I I I J
ATN3472,92P	AT3472,92P	VM	C	1.3g	White		1177		J
ATN3472,92E	AT3472,92EP	VM	E	1.3g	Orange or Green		1177E		K
ATN3600,50 ATN3601,51 ATN3651,52E	AT3600,50 AT3601,51 AT3651,52E	VM VM VM	C C E	2.5g 2.0g 2.0g	Red Yellow Green		1155 1155 1155E		J J K
ATN3606	AT3606	VM	C		Black		1308		J
ATN3710,12 ATN3711 ATN3711,12E	AT3710,12 AT3711 AT3711,12E	VM VM VM	C C E	2.5g 2.0g 2.0g	Red Yellow Green		1070 1070 1070E		I I J
ATN3721	AT3721	VM	C	2.0g	Yellow or Black		1114		I
ATN3830 ATN3831	AT3820 AT3831	VM VM	C C	2.5g 2.0g	Black Black		1168 1168		J J

AUDIO TECHNICA



Original Stylus Number	Original Cartridge Number	Cart-ridge Type	Stylus Tip	Tracking Force	Colour	Diagram	STYLUS		Price Code
							No.	or use:	
ATN3851	AT3851	VM	C	1.5g	Black		1187		J
ATPN1 ATPN2 ATPN3	ATP1 ATP2 ATP3	VM VM VM	C E E	4.0g 4.0g 2.5g	White White White		1322 1323E 1324E		J K K
ATPN4 ATPN5 ATPN6	ATP4 ATP5 ATP6	VM VM VM	C E E	3.0g 3.0g 3.0g	Red Blue Caramel		1226 1196E 1196E		J J J
ATPN7P ATPN8EP	ATP7P ATP8EP	VM VM	C E	1.3g 1.3g	Grey Green		1191 1302E		J K
ATS10 ATS10L,11 ATS11E ATS12 ATS12S	AT10 AT10L, 11 AT11E AT12 AT12S	VM VM VM VM VM	C C E E SH	2.5g 3.0g 2.0g 1.5g 2.0g	Red Grey Green Blue White		197 197 197E 197E 1012QD		I I J J L
ATS13, 14	AT13, 14	VM	E	1.0g	Red		1196E		J
ATXN1, 11 ATXN3, 5	ATX1, 11 ATX3, 5	VM VM	C C	2.0g 1.5g	Grey Grey		1061 1076E		J K
VM3 VM35EL	ATVN3 AT35X	VM VM	C E	2.0g 1.0g	Yellow Burgundy		1131 584E		I J

AWA									
Turntable/System No.									
250,971,1095,15+15,1444,1445 S23A, S27, S29, S45, SM23A, SM45, SP07, SP14	CE	C		6.0g	Black		1022	1055	F
15+15, FM21, S02, 18, 19, 20,26 SE18, 19, SM18, 19, 20, 21, 26 SM208, SMA15, SMB15 SP02, 03, 04, 05, 09, 19	CE	C		3.0g	Blue		594	164	I
867, 868, Blackbeat, Blackbeat 400/II SP07, SP14	MM	C		2.0g	Orange		1086		I
1411, 1412, 1413, 1414	CE	SR/2 SR/78		5.0g	White		442/2 442/7 8	88/2 88/78	C C
1415, 1443, B80, B421 OS10, 40, 50, 60, 70 SE12, SR100	CE	SR		6.0g	Metal		325		C
1416, 1417, 1424	MM	C		2.0-5.0g	Grey or Black		100		I
1441	MM	C		2.3g	Black		6870		I
1442	CE	SR/2 SR/78			Black Black		444/2 444/78		C C
4027, SP05M, SP06	MM	C		1.5g	TrYellow		1100	616	I

AWA

Turntable or System No.	Cart-ridge Type	Stylus Tip	Tracking Force	Colour	Diagram	STYLUS		Price Code
						No.	or use:	
4037 Blackbeat 400 S 03, SP 02,03,04,05,09,2,1119	MM	C	2.5g	Red or Orange		7730	7480	I
4047 SP08, 13	MM	C	3.0g	TrSmoke		184		I
B87, 409 Dimensional	CE	SR/2 SR/78	3.5g 3.5g	White White		88/2 88/78	442/2 442/78	C C
B411, 419 Tender	CE	SR/2 SR/78	4.5g 4.5g	White White		475/2 475/78	499	C C
B 411, 419	CE	SR	3.2g	White		1109	1193	C
B 420 QX 58	IM	SR	2.5g	White		508	493	I
B420 LT5V QX810, 5800	VM VM	SR SH	3.0g 2.0g	Grey White		197 525QD		I L
B 520	CE	SR		Metal		175		C
Blackbeat SP 07, 14	MM	C	2.0g	Orange		1086		I
Blackbeat 400/II SP 17	MM	C	2.0g	Orange		1287		I
Blackbeat 400/III Regency SP 12	MM	C	2.0g	Orange		1159		I
CD 100 S(M)24A, 25, 28, 34 SMA 25	MM MM	C C	3.0g 2.5g	Blue Red		1243 1208	1208 1243	I I
SP 01, SS 730	MM	C	2.0g	Red or White		6410		I
Disclplayer	MM	SH	2.0g	White		575QD		L
DP 84, 200, 210, 300 PP 300	VM	C	2.5g	Yellow		608		I
E 63 P L 70 LT45P, 100	VM	C	1.5g	Black		1187		J
LT 603	MM	C	3.0g	Orange		1224		I
QX 300, 520, 610 S 23A SM 2F, 22, 23, 32	CE	C	4.0g	Red or White		1153		I
S 38, 39, 43, 46, 300, 400 SM 43	VM	C	1..3g	White		1177		J
S 101, 201 SN 300	CE	C	4.0g	Red		1260		I

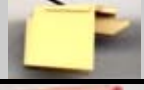
AWA



Turntable or System Number	Cart-ridge Type	Stylus Tip	Tracking Force	Colour	Diagram	STYLUS		Price Code
						No.	or use:	
S 200, 250 SM 38	CE	SR	5.0g	Black		1055		F
S 601, 802	VM	C	2.0g	Yellow		1155		J
X 10	VM	C	2.2g	Red		1071	1090	I

BSR

	TC2, 4	CE	LP		Metal		8		C
Monarch	TC8S, TC8H	CE	SR	6.0g	Metal		325		C
Monarch		CE	SR 78rpm		Metal Metal		35SR 35/78		C C
ST 3, 4	C1	CE	SR/2	3.5g	White		88/2	442/2	C
	SX1M, H	CE	SR/78	3.5g	White		88/78	442/78	C
ST 8, 9 ST 10	SC5M X3M, X5H	CE	SR/78	7.0g	White		403		C
		CE	SR/2	7.0g	White		404		C
ST 12, 14 ST 15	SC5M, X5M SX5M, SX6M	CE	SR/2	5.0g	White		442/2	88/2	C
		CE	SR/78	5.0g	White		442/78	88/78	C
ST 16, 17	SC7M, SC8M SC10, SC12M	CE	SR/2	4.5g	White		475/2	499	C
		CE	SR/78	4.5g	White		475/78		C
ST 19 ST 22 ST 23	X5M	CE	SR	5.0g	White		481		C
		CE	SR	5.0g	White		481		C
		CE	SR		Grey		481		C
ST 20 ST 21	SC7M SC10M	CE	SR	5.0g	White		499	475	C
		CE	SR	5.0g	White		499	475	C

Turntable/System No	Stylus No	Turntable/System No	Stylus No	Turntable/System No	Stylus No
C141 C198	511 1093	P128, 157 P207	558 1109	P232, 252, 256 P275	1093 499

CEC—CDC

C 2	C 2	MM	C	2.5g	White		200		I
CN 1, 2	MC 1, 2	MM	C	2.0g	Red		1060		I
CN 112		MM	C	3.0g	Red		1263		I

CEC - CDC

Original Stylus Number	Original Cartridge Number	Cart-ridge Type	Stylus Tip	Tracking Force	Colour	Diagram	STYLUS		Price Code
							No.	or use:	
CP 900	CP 900	CE	Stereo	6.0g	Metal		325		C
MC 2	MC 2, PC 1	MM	Conical	2.0g	Black or Blue		1096		I
MC 5	MC 5, MC 5 A	MM	Conical	3.0g	Blue, Red, Grey		533		I
MC 6	CZ 398/1	CE	Conical	5.5g	White		1138		F
MC 6 S	MC 6	MM	Conical	2.5g	White		165		I
MC7	MC7	MM	C	3.0g	White or Black		196		I
MC8S	MC8	MM	C	2.5g	Red		6330		I
MC9	MC9	MM	C	2.0g	Black		552		I
MC9A	MC9A	MM	C	3.0g	Yellow		184		I
MC10	MC10	MM	C	1.5g	Black		6430		I
MC11	MC11,YM118	MM	C	2.0g	Red		6300		I
MC12S		VM	C	2.5g	Grey		197		I
MC14	MC14	MM	C	2.2g	Red		569		I
MC16	MC16	MM	C	2.2g	TrRed		7730	7480	I
MC17	MC17	MM	C	1.8g	Black		1081		I
MC20	MC20	MM	C	2.2g	Red		569		I
MC45	MC45	MM	C	1.8g	Red		1169		I
MC392		CE	C	4.0g	Red		1260		I
MM1, RS1	MC2, PC1	MM	C	2.0g	Black		1096		I

CEC - CDC

Original Stylus Number	Original Cartridge Number	Cart-ridge Type	Stylus Tip	Tracking Force	Colour	Diagram	STYLUS		Price Code
							No.	or use:	
MM3 RS3	MC3	MM	Conical	1.5g	TrGreen		1172	1003	I
N103		VM	Conical	1.3g	Black or White		1177		J
ST630		IM	Conical	1.3g	Transparent		1215		J
STP 333		CE	Conical	3.0g	White		163		I
VC10S		VM	Conical	2.0g	Grey or Yellow		608		I
CN234		MM	Conical		Red		1299		I
FF15EO/II		MM	Elliptic	2.0g	Red		1029E		J
N5P		MM	Conical		Black		1295		I
Stylus5		MM	Elliptic	1.25g	Black		1229E		J

Turntable/System No	Stylus No	Turntable/System No	Stylus No	Turntable/System No	Stylus No
BA300	569	BD8200	608	ST610	1177
BD55, 65	Replacement Stylus unavailable	Disco4000	supplied without cartridge	ST630	1215
BD95	1299	HS210, 310, 510	1029E	STP64	200
BD515, 516, 616	533	RS17	1081	STP65	533
BD2200	569	ST110	1096	STP67, 68	165
BD3000	533	ST210	1177	STP69	196
BD3200, 5200, 6000	569	ST215	1295	STP90	325
BD8001	1081	ST230	1177	STP92	165
BD8200	1096	ST310	1029E	STP93	196
BD8002A	1172	ST333	163	STP95	533
BD8003	1081 or 1096	ST510, 512	1172	STR1500H	325
BD8004	1096	ST520, 530	1229E		

COLLARO

DC284		CE	SR		Metal		44		C
O, P, T		CE	LP		Metal		17		C
PX		CE	LP		Metal		26		C
Stereo C		CE	SR		Metal		65		C
TX88		CE	LP		Metal		42		C









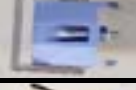
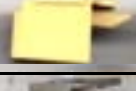

COLLEL

Original Stylus Number	Original Cartridge Number	Cart-ridge Type	Stylus Tip	Tracking Force	Colour	Diagram	STYLUS		Price Code
							No.	or use:	
SC1		CE	Stereo		White		78		C
COLUMBIA—DENON									
DSN1	PU440, 450	CE	SR	6.0g	Metal		325		C
DSN5	PU830, 831	CE	C	4.0g	Nickel		7100		I
DSN6	PU803, 822	MM	C	5.0g	White		1133		I
DSN9	PU1229 PU1230	MM	C	4.5g	White		7090		I
DSN10, 11, 12 DSN13, 18	PU1340, 1344 SMC250	MM	C	4.5g	White		165		I
DSN14, 17	GM10	MM	C	2.5g	Red		7080		I
DSN15	PUH30	MM	C	2.8g	White or Green		180		I
DSN16 DSN21	JC16, PU1557 PU1623, 1665	CE	Stereo		Metal		175		C
DSN19	EPU1, 24	CE	Stereo	6.0g	Metal		325		C
DSN22	GV1, PW1676	CE	C	2.0g	Grey		7110		I
DSN23	JN10 PU1678	MM	C	2.5g	Grey or Red		165		I
DSN24	GM20	MM	C	2.5g	Red		492		I
DSN25	JM11	CE	C	2.5g	Red		7120		I
DSN28	JM12	VM	C	2.8g	Yellow or Beige		197		I
DSN30	JM13	VM	SH	2.0g	White		525QD		L
DSN32	JC22	CE	C	4.0g	Orange or Green		1003		I
DSN34	PU1220	MM	C	4.0g	White, Blue or Red		6410		I
DSN35, 36	DL109	MM	E	1.8g	White or Black		1062E		J
DSN37	DL8	MM	C	2.0g	TrBrown		7070		I

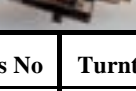

COLUMBIA DENON

Original Stylus Number	Original Cartridge Number	Cart-ridge Type	Stylus Tip	Tracking Force	Colour	Diagram	STYLUS		Price Code
							No.	or use:	
DSN38	JC23	CE	C	3.5g	White		516		I
DSN39	JM18	VM	C	2.0g	Yellow		608		I
DSN40 DSN41	DL108D DL109R	MM MM	C C	1.8g 2.3g	White Black		1058		I
DSN42	DL109D	MM	C	2.0g	Black		7070		I
DSN44	JM20	MM	C	2.2g	Black		7480	7730	I
DSN45	JC24	CE	C	6.0g	Black		1022	1055	F
DSN47	JM20	MM	C	2.2g	Red		7730	7480	I
DSN48	JM22	MM	C	2.0g	Red		1060		I
DSN49		VM	C	2.0g	Yellow		608		I
DSN50	JM24	MM	C	2.0g	Orange		1086		I
DSN51	JM26	MM	C	2.0g	Orange		1159		I
DSN54		VM	E	2.0g	Green or Blue		197E		J
DSN55	JM29	MM	C	2.0g	Orange		1160		I
DSN57		MM	C	2.5g	Red		1208	1243	I
DSN60	DL60	MM	C	2.0g	White		1162		I
DSN61	DL61	MM	E	1.25g	Grey		1213E		J
DSN62	DL62	MM	E	1.25g	Grey		1214E		J
DSN63		VM	C	2.0g	Black		1168		J
DSN65	DL65	MM	C	2.0g	Red or White		1162		I

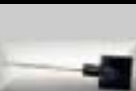

COLUMBIA - DENON

Original Stylus Number	Original Cartridge Number	Cart-ridge Type	Stylus Tip	Tracking Force	Colour	Diagram	STYLUS		Price Code
							No.	or use:	
DSN66		MM	C	1.25g	Blue		1243	1208	I
DSN67	DL007	MM	C	1.25g	Red or Blue		1190		I
DSN68		MM	C	2.0g	Red or Blue		1258		I
DSN72		VM	C	2.0g	Yellow		1155		J
DSN81, 82		VM	C		Grey Black		1308		J
DTS5	PW1490	CE	SR	6.0g	Black		443		C
SJN18	JC23	CE	SR	3.5g	Grey		516		F
SJN45	JM45	CE	SR	6.0g	Black		1022	1055	F
SJN68		CE	C	6.0g	Red		1260		I
Stylus 5E	OM5E	MM	E	1.25g	Black		1229E		J
S300ME		IM	E	1.8g	TrSmoke		1150E		J
Turntable/System No	Stylus No	Turntable/System No	Stylus No	Turntable/System No	Stylus No				
DP2 DP3 DP5 DP7F DP10F, 11F, 14F, 15F, 21F DP26F, 29F	1208 1213E 1214E 1229E 1162 1308	DP28F DP30L DP31L DP33 DP35F, 37F, 45F, 51F, 65F DP1200	7070 1162 7070 1162 1150E	DPF3 DPR2, 25 S45-70 SLD55 System1, 2	1258 1168 7070 608 1162				
CONER									
33	A1, 2	CE	SR	6.0g	Metal		455		C
RCS	RCS	CE	SR	6.0g	Black		503		C
CONVER COSMO									
Mk.23		CE	SR		Black		449		C

CROWN

Original Stylus Number	Original Cartridge Number	Cart-ridge Type	Stylus Tip	Tracking Force	Colour	Diagram	STYLUS		Price Code
							No.	or use:	
AMXA1		VM	C	2.0g	Yellow		608		I
AMXA2, 5 AMXA86, 90		VM	C	3.0g	Beige		197		I
MZ1100,2100 CD2000S		CE	C	4.0g	Red		1260		I







DIOTRAN

TA5A, 6		MM	C	3.0g	Red		492		I
TA7		MM	C	2.0g	Blue		579		I

DECCA

Decca H		CE	LP		Metal		21		C
Decca XMS		CE	LP		Metal		22		C
Deram		CE	C		Blue		156		I
Hi-Fi 12		MM	C	2.0g	Red		1001		I



DUAL

DN1	CDS1	CE	SR/2		Metal		216		C
DN2,21,22,24 DN3, 32, 34	CDS2, 3, 310 CDS310, 320	CE CE	LP/78 SR/78	5.0g 5.0g	Blue Brown		32 63		C C
DN4, 23, 24	CDS620	CE	SR	5.0g	Green		318		C
DN5, 52, 54	CDS630	CE	SR/2 SR/78	4.5g 4.5g	White White		96/2 96/78		C C
DN6, 62-65 DN8, 83, 85	CDS640, 651	CE	SR/2 SR/78	4.5g	Red		474		C
DN93, 94, 96		CE	SR	4.5g	Red		335		I
DN101	DM101G	MM	C	1.2g	Red		186		I

DUAL

Original Stylus Number	Original Cartridge Number	Cart-ridge Type	Stylus Tip	Tracking Force	Colour	Diagram	STYLUS		Price Code
							No.	or use:	
DN105		MM	C	2.0g	Blue		1258		I
DN110, 220	MCC110	VM	E	1.3g	Caramel		1196E	1226	J
DN140S DN145E DN145S	ULM40 ULM45E ULM45S	MM MM MM	C E C	2.5g 1.5g 1.5g	Black Black Black		1145 1145E 1145		I J I
DN149S DN150E DN152,155E DN160E	ULM49S ULM50E TKS52,55E ULM60E	MM MM MM MM	E E E E	1.5g 1.5g 1.5g 1.0g	Black Black Black Black		1146E 1146E 1146E 1146E		J J J J
DN165 DN166E DN167	ULM65 ULM66E ULM67	MM MM MM	E E E	1.25g 1.25g 1.25g	Black Black Black		1229E 1229E 1229E		J J J
DN201, 202	DMS200	VM	C	2.5g	Red		609		I
DN211,221 DN237,241	DMS210, 220 DMS237,240E	VM VM	C E	2.5g 2.0g	Red Black		1037 1037E		I J
DN235 DN239 DN251E	DMS235 DMS239 DMS251E	VM VM VM	C C E	2.5g 2.0g 2.0g	Black Yellow Green		1167 1155 1155E		J J K
DN245 DN249E	DMS245 DMS249E	MM MM	C E		Black Black		1295 1296E		I J
DN301	SP1	MM	C	2.5g	Red		311		I
DN305,306	M44G	MM	C	1.2g	White		387	424	I
DN311	V15/DAC	MM	C	3.0g	Grey		100		I
DN314,314	V15/DAM	MM	C	3.0g	Black		100		I
DN320,321 DN323,325	M75MG M73,75MG	MM MM	C C	1.2g 1.2g	Beige Beige		414 414		I I
DN330, 340 DN345	M91MG DM103ME	MM MM	C E	1.2g 1.2g	Red Yellow		186 186ED		I J
DN350	M20E	MM	E	1.0g	Black		6700E		J
DN352	V15/II	MM	E	1.2g	Black		532E		J
DN353	FF15.O/II	MM	C	2.0g	Red		1029		I
DN360DN362	M95HE	MM	HE	1.2g	Black		606HE		K

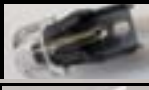
DUAL





Original Stylus Number	Original Cartridge Number	Cart-ridge Type	Stylus Tip	Tracking Force	Colour	Diagram	STYLUS		Price Code
							No.	or use:	
DN365	M75G	MM	C	1.2g	Grey		454	414	I
DN380E DN390E	TKS380E TKS390E	MM MM	E E	1.5g 1.0g	Black Black		1276E 1277E		J J
DN450	MPP450	VM	C	1.3g	Blue		1177		J
	XV15/1200E	IM	E	0.5-1.5g	Black		6950E		J

Turntable/System No	Stylus No	Turntable/System No	Stylus No	Turntable/System No	Stylus No
CS90,100,120,123,138 CS110,130,135 CS415,445 CS420,421,430 CS435-1 CS461 CS481,510 CS491 CS496 CS501 CS502 CS503 CS504,505,521 CS505-1 CS505-2 CS506,508,522 CS511,514,520 CS515	1155 1073 or 1145 1155 474 975 454 606ED 1073 1145 810E 454 or 6950E 1296E 1073 1146E 1155 or 1229E 1145 1155 1229E	CS525,CS610Q CS528,606,607 CS530,616Q,620Q,630Q CS601 CS604,621 CS617Q CS622,626,627,628,650RC CS701 CS704,721 CS714,728Q,731Q CS714Q CS741Q CS1004,1007,1008 CS1009,1010,1015,1016 CS1011 CS1019,1212 CS1209	1155 1145 1229E 609 or 6700E 1073 1073 or 1229 1145 6700 or 532E 532E 1276E 1196E 1277E 32 387 63 387 186	CS1214 CS1215 CS1216,1218,1219 CS1220,1224,1234 CS1222 CS1225,1226,1228 no Cartridge supplied CS1229 CS1236,1237 CS1239 CS1242 CS1245 CS1246,1254 CS1249 CS1256,1257,1258 CS1260,5000 CS2110 CS3510	454 414 186 or 414 474 609 or 1073 186 or 414 414 or 1029 414 or 606E 1073 or 6700E 606ED 1073 or 606E 186 or 606E 1145 1229E 1295 1177



ELAC

D144-17 D244-17 D344-17 D444-12	STS144-17 STS244-17 STS344-17 STS444-12	MM MM MM MM	C C C C	2.2g 2.2g 2.2g 1.2g	Green Grey White Black		469 469 470 471		I I I I
D155-17 D255-17 D355-17 D355E D455-12 D455E D555-12 D555E D655-D4	STS155-17 STS255-17 STS355-17 STS355E STS455-12 STS455E STS555-12 STS555E STS655-D4	MM MM MM MM MM MM MM MM MM	C C C E C E C E SH	2.2g 2.2g 1.5g 1.5g 1.2g 1.2g 1.5g 1.5g 2.0g	Black Black Black Black Black Black Black Black Black	 	7330 1006 7220 7720E 1008 1009E 1011 1007E 1064QD		I I I J I J I J L
D791, 792E D793 D794E, 795E	ESG791, 792E ESG793 ESG794, 795E	MM MM MM	E C E	1.8g 1.4g 0.75g	Black Black Black		1216E 1216 1325E		J I J
SM2, DM2	MST2	CE	SR		Metal		67		C
SNM9	KST9	CE	SR/2		Metal		58		C
SNM11	KST11	CE	SR/2		Metal		59		C
SNM14	KST14	CE	SR/2		Metal		237		C

ELAC

Original Stylus Number	Original Cartridge Number	Cart-ridge Type	Stylus Tip	Tracking Force	Colour	Diagram	STYLUS		Price Code
							No.	or use:	
SNM100, 101 SNM102 SNM103	KST100, 101 KST102 KST103	CE CE CE	SR SR SR	5.5g 5.5g 5.5g	White White White		233 234 235		C C C
SNM106,112	KST106, 112	CE	SR/2		White		78		C
SNM107	KST107	CE	SR		White		334		C
SNM402	KST402	CE	SR/2		White		330		C





ELECTRO VOICE

EV21, 26	EV27,57,86	CE	SR	5.0g	Metal		74		C
EV2616	EV117, 131	CE	SR/2		Yellow		303		C
EV2619	EV132, 163	CE	SR/2		Black		316		C
EV2626	EV37,38,47	CE	SR/2		Black		337		C
EV2620 EV2622	EV141,149 EV150	CE	SR/2		Black		338		C

ER - ELECTRONIC REPRODUCERS

Compact A2 ER2SX ER5MB ER5SB ER35,36,40	Compact A, C ER2SB ER5MX	CE CE CE CE	SR/2 SR SR/2 SR/2	5.0g 5.0g 5.0g 5.0g	Black White Black Black		413 91 85 430		C C C C
ER60		CE	SR/2		White		49		C
ERC450M		MM	C		Red		1014		I
ERC750		CE	SR	6.0g	Metal		35		C
ERC800		CE	SR	6.0g	Metal		325		C
ERC900		CE	SR/2	5.0g	Black		476		C

EMERSON

Turntable/System No.	Cart-ridge Type	Stylus Tip	Tracking Force	Colour	Diagram	STYLUS		Price Code
						No.	or use:	
112AM	CE	SR	6.0g	Metal		325		C
5100 M2430, M2700	CE	SR/78 SR/2	4.5g 4.5g	White White		475/78 475/2		C C
M2410	CE	SR	3.2g	White		1109		C
MC259, 1100, 1400 MC1500, 2590, 2593	CE	SR	6.0g	Black		1022	1055	F





EXCEL

S45	ME45	MM	C	2.2g	Blue or Green		1310		I
S55	ME55	MM	C	1.8g	Red		1081		I
S65	ME65	MM	C	2.0g	Clear		1170	1172	I
S65E	ME65E	MM	E	2.0g	TrGreen		1195E		J
S70ER S70EX S70FR S70HR S70SR S70X4	ES70E ES70EX ES70F ES70H ES70S ES70X4	MM MM MM MM MM MM	E E C C C SH	1.3g 1.3g 1.3g 3.5g 1.8g 1.3g	Red TrBrown Blue or Yellow Blue Blue Red		173E 174E 170 171 170 201QD		J J I I I L
S75QH	ES75QH/SS	MM	SH	1.3g	Blue		604QD		L
S75QL	ES75QL	MM	SH	1.3g	Yellow		604QD		L
S300C	ESP300C	IM	C	1.25g	Clear		1215		J
S700CR,MC15 S700ER S700XR	QD700C QD700E QD700X	MM MM MM	C E SH	1.5g 1.5g 1.5g	Blue Red Yellow		579 603E 604QD		I J L





EUPHONICS

U10		CE	SR/2		Gold		355		C
-----	--	----	------	--	------	--------------------------------------------------------------------------------------	-----	--	---

EXPO

3850		CE	SR/2		Black		520		C
6862, 6863, 6864 MC1500		CE	SR	6.0g	Black		1055	1022	F
AC129, C198, Discotek MC12F, MC13F, PA205, PA295, PX37H		CE	SR/78 SR/2	4.5g 4.5g	White White		475/78 475/2		C C
DAP123, 141, 153		CE	SR/78 SR/2	5.0g 5.0g	White White		442/78 442/2	88/78 88/2	C C

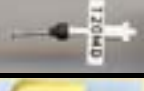
EXPO

Turntable/Cartridge Number	Cart-ridge Type	Stylus Tip	Tracking Force	Colour	Diagram	STYLUS		Price Code
						No.	or use:	
DCP128, DCP157 MX56	MM	C	3.0g	White		6270		I
HS3610, HS8527 MC200 MCE100	CE	C	6.0g	Black		1022	1055	F
MC1930, MC7600 MCE22	CE	Stereo	3.2g	White		1109		C
MS29H	MM	C		Yellow		1156		I
RP1000, RP1100	MM	C	2.5g	Beige		564		I

GARRARD

ADS BDS CDS	KS40A KS41B KS41C	CE CE CE	SR/2 or SR/78	4.0g 4.0g 4.0g	Black Black Black		444/2 444/78		C C
GC2		CE	LP or 78rpm	5.5g	Metal		18		C
GC8		CE	LP		Metal		39		C
GC11		MM	C	2.0g	Orange		1159		I
GC12	GCE12	CE	C	5.5g	Metal		64		C
GCM21, 22	GKM24	CE	SR/2 SR/78	4.0g	Black		430/2 430/78	431	C C
GCM21T	GKM24T	CE	SR	4.0g	Black		436		C
GCS10		CE	SR	5.5g	Metal		47		C
GCS23	GKS25	CE	SR/2		Black		431		C
GCS23T	GKS25T	CE	SR		Black		434		C
GDS1,GSS1	GCS35, 36	CE	SR/2	8.0g	Black		445		C
GDS2	GCS38	CE	SR/2	5.0g	Grey		446		C
GMN50C		VM	C	2.0g	Blue		563		I
GS22 GS22E		VM VM	C E	1.5g 1.5g	Black Black		1175 1212E		I J
V100, 101		MM	C	2.3g	Black		6870		I
Zero 100		MM	E	1.1g	Black		541E		J

GARRARD

Turntable/System No	Stylus No	Turntable/System No	Stylus No	Turntable/System No	Stylus No
35SB, 125SB 50Mk.II 86Mk.II 1025T 1255B 2671D 5200C,6100C,6200C,6300C	551 263 847E 444 508 1051 444	6300, 6400 AP76 AT6K CC10 DD75 G100, 200 G300	414 507 263 444 456E 444 414	GC11 GC22 GT55D M62, SL55 SL40B SL65 SP25/III	984 1051 456E 444 387 387 691

GENERAL ELECTRIC

Original Stylus Number	Original Cartridge Number	Cart-ridge Type	Stylus Tip	Tracking Force	Colour	Diagramm	STYLUS		Price Code
							No.	or use:	
GC2, 7	T-Holder	CE	SR		Metal		262		C
GC200		CE	SR/2	4.5g	White		336		C
GC500		CE	SR/2		Blue		344		C
GC650		CE	SR/2	4.5g	Blue		395		C
GC660		CE	SR	4.5g	Black		513		C
KP20B MST5	KPU20B M32	MM	C	3.2g	LtGreen		534		I
KP25	KPU25	MM	C	3.5g	Ivory		161		I
KP40	KPU40, 45	MM	C	2.5g	Red		501		I
MST6		MM	C	2.8g	Beige		1143	505	I
MST31		MM	C	2.2g	Orange or Blue		7450		I
N46398		CE	SR		Black		1022	1055	F
RPJ/RPX		CE	SR		Metal		227		C
S100L		VM	C	2.5g	Grey		197		I
VR11-4G		CE	LP		Gold		212		C
VR22	T-Holder	CE	LP		Gold		279		C
14+14		CE	SR/2 SR/78	4.5g	Black		444/2 444/78		C C



GENERAL ELECTRIC

Turntable/System No	Stylus No	Turntable/System No	Stylus No	Turntable/System No	Stylus No
DCP180A MC500, 700 PL40	1022 1022 7450	PL390, 800, 850 PL1000 PL1010	1143 608 534	PL2007 PL2020 System 390	475 534 608





GOLDRING

Original Stylus Number	Original Cartridge Number	Cart-ridge Type	Stylus Tip	Tracking Force	Colour	Diagram	STYLUS		Price Code
							No.	or use:	
CM50	SX10	CE	SR		Metal		61		C
CS60	MX1, 2	CE	SR	4.5g	Metal		60		F
CS80	MX4	CE	SR	4.5g	Metal		81		F
CS90 CS91E		CE CE	SR E	4.0g	White White		90 94E		F J
D110 D110DJ D110E D110SE	G800 G800DJ G800E G800SE	IM IM IM IM	C C E HE	3.0g 2.2g 1.5g	White Yellow Grey Grey		110 110DJ 110E 110SE		I J J K
D120	G850	IM	C	3.0g	Red		120		I
D130 D130DJ D130E D130SE	G820 G820DJ G820E G820SE	IM IM IM IM	C C E HE	3.0g 1.5g 1.5g	Lilac Red Beige Yellow		130 130DJ 130E 130SE		I J J K
D140E	G900E	MM	E	1.0g	Black		6210E		J
	ELAN ELEKTRA	MM MM	C E	1.5-3.0g 1.5-2.0g	Red Blue or Orange		1190 1190E		I J

GLENWOOD

Turntable/System No. 8839	CE	C		4.0g	Red		1260		I
Turntable/System No. M22	MM	C		2.5g	Red		1208	1243	I
Turntable/System No. TP707	VM	C		1.3g	White		1177		J

GOLDSTAR

GCD21P	CE	C		4.0g	Red		1260		I
GCD60	MM	C		2.5g	Red		1208	1243	I
GCD82P GSA5300, 5420, GSP208	VM	C		2.0g	Yellow		1155		J
GSE380A	VM	C		2.0g	Yellow		1226		J

HANIMEX

Turntable or System No.	Cart-ridge Type	Stylus Tip	Tracking Force	Colour	Diagram	STYLUS		Price Code
						No.	or use:	
Delta 5, Microtech, S 197 HRC7815, 7818, 8010, 8020 HSS 7505, 7815, HTT 7100 P128, 204, 207, 208, RP247	CE	SR/2 or SR/78	4.5g	White		475/2 475/7 8	499	C C
HMC 7606 P 247	CE	SR	5.0g	White		499	475	C
HMC 7811 HRC 7080	CE	SR		Black		520		C
HRC 7010	CE	SR/2		Black		445	446	C
HSS 7303 HST 303	CE	Conical	3.0g	Blue		594	164	I
HTT 7200 Microtech P 200, 232	IM IM	Conical Elliptic	4.0g 3.0g	DkGrey DkGrey		1093 1094E		I J
HEALING								
3 in 1, 45254 Sceptre 80 Stereo 10	VM	Conical	3.0g	Beige		197		I
C 2-87 H 202	CE	Stereo	6.0g	Metal		325		C
HD 7010 HRC 5060	CE	Stereo		Black		520		C
HMC 7080, 7810	MM	Conical	3.0-7.0g	Grey		187		I
Lyric N 3-4, N 22-35	CE	SR/2 SR/78		Gold		82/2 82/78		C C
MC 201	MM	Conical	2.0-2.5g	LtGreen		539		I
MS 650, 651, 850 RBT 10, RP 5, RPS 10C Stowaway, TG 40, TG 44	CE	SR/2 SR/78	4.5g 4.5g	White White		475/2 475/78	499	C C
P 302, 303, 606	MM	Conical	2.0-2.5g	Orange		7450		I
PL 500, SX 500	MM	Conical	4.0g	Red		492		I
Stereo 10	MM	Conical	1.5-3.0g	Beige		414	498	I
TM 20	MM	Conical	3.0-5.0g	LtBlue		424		I





HITACHI

Original Stylus Number	Original Cartridge Number	Cart-ridge Type	Stylus Tip	Tracking Force	Colour	Diagram	STYLUS		Price Code
							No.	Or use:	
DS-4T	XFS200	CE	SR/2 SR/78	6.0g	White		88/2 88/78	442	C C
DS-5T	HRD100, 101	CE	SR	5.0g	White		499	475	C
DS-ST1	XTS120	CE	SR or 78rpm	6.0g	Gold		35 35/78		C C
DS-ST3	MFS170, 171	MM	C	2.5g	White		165		I
DS-ST5	IFS240	IM	C	3.0g	White		504		I
DS-ST7		VM	C	3.5g	Yellow		1155		J
DS-ST8	MT8	MM	C		Yellow		1309		J
DS-ST9	XTS140	CE	SR	6.0g	Gold		325		C
DS-ST12, 14		VM	C	1.3g	Grey		1177		I
DS-ST13		VM	C	1.3g	Green		1191		J
DS-ST15		MM	C	2.0g	Beige		1097		I
DS-ST16		VM	C	1.7g	Black		1168		J
DS-ST17		VM	C	2.0g	Red		1226		J
DS-ST18		VM	E	1.3g	Black		1177E		K
DS-ST19	DPK190	CE	SR	5.0g	Nickel		175		C
DS-ST20	CFS280	CE	C	3.5g	Nickel		568		F
DS ST23	MT23	MM	C	2.0g	Red or White		6410		I
DS ST24	MT24	MM	C	2.0g	TrOrange		7760		I
DS ST 25	MFS250	MM	C	2.5g	Red		7180		I

HITACHI









Original Stylus Number	Original Cartridge Number	Cart-ridge Type	Stylus Tip	Tracking Force	Colour	Diagram	STYLUS		Price Code
							No.	or use:	
DS-ST26	VFS260, 261	VM	C	2.0g	Yellow		197		I
DS-ST26E	VFS260E	VM	E	1.5g	Ivory		584E		J
DS-ST30	MT30	VM	C	2.0g	Yellow		608		I
DS-ST32		IM	C	2.3g	Red		1183		I
DS-ST33 DS-ST33E		VM VM	C E	1.3g 1.3g	Grey Black		1191 1302E		J K
DS-ST35,36 DS-ST41		VM	C	2.0g	Red		1071	1090	I
DS-ST40	MT22	MM	C	2.0g	Red		539		I
DS-ST55	HTL55	MM	C	1.0g	TrBlue		1188		I
DS-ST70		MM	C	1.25g	Black		1218		I
DS-ST101	YM114	IM	C	1.1g	White		556		I
DS-ST102	MT102	MM	C	3.0g	Blue		545		I
DS-ST103	MT103	IV	C	2.0g	Black		6750		I
DS-ST104		VM	E	1.5g	Blue		1004E		J
DS-ST110		MM	C	2.3g	Black		6870		I
E50MC E150		VM VM	E E	1.7g 1.3g	Black or Caramel		1196E 1196E	1226 1226	J J
F11	MT11F	MM	SH	1.8g	White		548QD		L
F22	MT22	MM	SH	2.0g	Brown		540QD		L
F23	MT23	MM	SH	2.0g	Brown		575QD	646	L
MT13		VM	E	1.3g	Green		1302E	1191	K

HITACHI

Original Stylus Number	Original Cartridge Number	Cartridge Type	Stylus Tip	Tracking Force	Colour	Diagram	STYLUS		Price Code
							No.	or use:	
SJN18		CE	C	5.0g	Red		7650		I
SJN45		CE	C	6.0g	Black		1022	1055	F
		MM	C	2.5g	Red		1208	1243	I
		MM	C	3.0g	Beige		1143	505	I

Turntable/System No.	Stylus No.	Turntable/System No.	Stylus No.	Turntable/System No.	Stylus No.
3 in 1 DKP86, 87, 89, 305 HT03 HT1, 2, 3, 7 HT6M HT10RM HT12 HT17 HT20, 21, 26, 28 HT40, 41S, 60S, 65S HT44L, 55L HT45, 50, 51 HT53L HT61S, 72, 85, 301 HT66S, 205 HT67, 68 HT101, 202, 207 HT300 HT301, 324, 354, 356	556 165 1196E 1177 1071 197 1177 or 1208 608 or 1177 1071 or 1097 1071 1155 1097 1208 608 1097 1071 1177 1309 608	HT320, 350, 353, 460 HT405, 415 HT463, 500 HT464 HT508 HT550, 561, 660 HT840 HTD30W HTG2 HTL5, 70 HTL33 HTL55 HTW07, 08 MD02, 11, 12 MD26, 28 MT03 PS8, 10, 12, 14, 15, 17 PS22 PS33, 38, 48, 58	197 1071 1004E 608 1097 1004E 197 1177 1097 1218 1177 1188 1177 1177 1177 1155 197 165 197	SDT44L SDT53L SDT55L SDT60 SDT110J SDT115R SDT150 SDT150R, 782R SDT300 SDT1105 SDT2660, 2690 SDT3420 SDT6290R SDT7580, 7660 SDT7675 SDT7711 SDT7765, 7825 SMD50 TL10S	1155 1177 or 1208 1155 or 1188 1071 or 1155 545 499 1071 6870 6750 1143 556 1196E 7180 6750 197 or 6750 325 545 or 6750 1155 545 or 6750

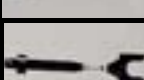







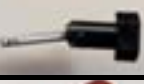

HMV

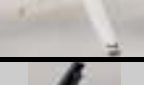
HM2, HS4		CE	LP		Metal		8		C
HM4		CE	LP SR		Copper Copper		18LP 18SR		C C
HM5, HS7		CE	LP	5.0g	Nickel		16		C
HM6, HS8		CE	LP		Copper		17		C
HM7, HS9		CE	LP		Metal		25		C
HM8, HS10		CE	LP		Metal		31		C
HM9, HS11		CE	SR 78rpm	6.0g	Gold Metal		35SR 35/78		C C
HM10, HS12		CE	LP		Metal		24		C

HMV

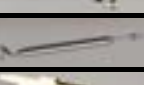
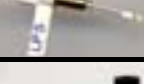
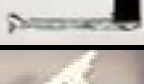
Original Stylus Number	Original Cartridge Number	Cart-ridge Type	Stylus Tip	Tracking Force	Colour	Diagram	STYLUS		Price Code
							No.	or use:	
HS13		CE	SR		Silver or Gold		44		C
HT5		CE	LP/78	5.0g	Blue		32		C
HT7		CE	SR/2 SR/78		White White		96/2 96/78		C C
HT8		CE	SR/2 SR/78		Gold Gold		82/2 82/78		C C
HV1D HV5D		CE	SR	5.0g	Nickel		47		C
HV2D HV3D		CE CE	SR 78rpm	6.0g 6.0g	Gold Gold		35 35/78		C C
HV6D		CE CE	SR/2 SR/78	5.0g 5.0g	White White		88/2 88/78	442 442/78	C C
HV7D		CE CE	SR/2 SR/78	4.0g 4.0g	Grey Grey		328/2 328/78	332 332/78	C C
HV8D, 9D HV10D		CE CE	SR/78 SR/2	5.0g 5.0g	White White		403/78 404/2		C C
HV11D HV12D		CE CE	SR/2 SR/78	4.5g 4.5g	White White		442/2 442/78	88/2 88/78	C C
HV13D		CE CE	SR/2 SR/78	4.5g 4.5g	White White		475/2 475/78	499	C C
HV14D		VM	C	3.0g	Beige		197		I
HV15D		CE CE	SR/2 SR/78	4.5g 4.5g	Black Black		444/2 444/78		C C
HV16D		CE	SR	6.0g	Gold		325		C
HV17D		CE CE	SR/2 SR/78	4.5g 4.5g	Grey or Yellow		332/2 332/78		C C
HV18D		CE	SR		Yellow		423		C
HV19D		CE CE	SR/2 SR/78	4.5g 4.5g	Yellow or Red		464/2 464/78		C C
HV20D		CE	SR		Black		503		C
HV21D		CE	LP		Copper		18		C
HV22D		CE	SR/2		White		87/2		C

HMV

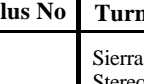



Original Stylus	Original Cartridge Number	Cart-ridge Type	Stylus Tip	Tracking Force	Colour	Diagram	STYLUS		Price Code
							No.	or use:	
HV23D		CE	SR/2		Yellow		295	332	C
HV24D		CE	SR/2		Black or White		97		C
HV25D		MM	C	3.5g	Red		311		I
HV26D		CE	SR/2		Yellow		342		C
HV27D		CE	SR/2		Clear		490		C
HV28D		CE	SR/2		Black		430		C
HV29D		CE	SR/2		Gold		82		C
HV30D		CE	SR/2		Black		445		C
HV31D		CE	SR		Metal		52		C
HV32D		CE	SR		Metal		286		C
HV33D, 34D		CE	SR/2		White		87		C
HV35D		CE	SR		Green		318		C
HV36D		CE	SR/2		White		96		C
HV37D		CE	SR/2		Metal		474		C
HV39D		MM	C	2.2g	Beige		414		I
HV40D		CE	SR		Silver		44		C

Turntable/System No	Stylus No	Turntable/System No	Stylus No	Turntable/System No	Stylus
01-9H, Bermuda, Caprice, N3-43	328	H5-8N, H6-8N, Imperial, JF8N	88	Sierra, SS707, 808, Tasman	442
02-8J, 05-4G, 8+8, Bahama	88	Intercept, International, Malibu	88	Stereo10, 20	414
03-8K, CC8-8D, H7-8P, TL44	442	Mercury, Vagabond, TR07-4M	404 or 442	Stereomaster	88
04-4B	88 or 444	Lyric	82	Stowaway, TG40, TG44	475
04-4R, 06-4L, CB80, Kingston	403 or 442	MC200	325	Stratford, Studio 7	328
Apollo, Stowaway, TG40, TG44	475	MC201, PL500	539	T1-41, T5-47, T9-4A	328
Audio10	332	Monaco, Nippergram	88	T2-69, T8-4D, 49D	88
C9-8N, Cavalier, Graduate	88	N2-22, 2-35, N3-4Z, Tablegram	82 or 332	TC48, TH45, TL42, U2-8N	88
BSR 74564	414	P606	7450	Triad	197
BSR TJD4X, Music Centre	197	PL100	720	Universal 302, 303	7450
C8-8M, Minigram	404	QB4A, 45, Quadrophonic, TO48	444	V1-2D, V1-3D, Westpoint	328
Calais, Escort, OC48	444	QD49, Statesman, Sierra, TH41	442	Zodiac	197
CX700, JH300	594	Rhapsody, Safari, Sheraton	88	Zodiac/II	475
Electrogram	35	Sceptre80	197		



JELCO

Original Stylus Number	Original Cartridge Number	Cart-ridge Type	Stylus Tip	Tracking Force	Colour	Diagram	STYLUS		Price Code
							No.	or use:	
Apan Blue		MM	C	2.0g	Blue		545		I
ND5D	MC5	MM	C	4.0g	White		512		I
ND9A	MC9A	MM	C	2.3g	Yellow		184		I
ND12D	MC12D	MM	C	1.8g	Red		6330		I
ND14D	MC14D	MM	C	2.2g	Red		569		I
ND15D	MC15D	MM	C	2.0g	Green		6350		I
ND17	MC17	MM	C		Black		6750		I
ND20	MC20	MM	C	1.7g	Red		569		I
ND45D	MC45	MM	C	1.7	Red		1169		I
ND50D "D"	MC50	MM	C	1.5g	Black		1139		I
ND62	MC62	MM	C	1.2g	Blue		1256		I





JOERGAN

JS1, SJ1		CE	C	3.0g	Blue		594	164	I
JS4, TS1000	MAG525	IM	C	4.0g	Grey		1093		I
S5		CE	SR	3.0g	White		1109		C
TP500P		MM	C	2.0g	Black		552		I

JVC NIVICO JAPAN VICTOR

4DT1X, 2X 4DT5X 4DT10X	4MD1X, 2X 4MD5X 4MD10X	MM	SH	1.8g	White		548QD		L
4DT20X	MD1019	VM	LC	2.0g	Burgundy		583QD		L
4DT30X		VM	LC	3.0g	Ivory		525QD		L

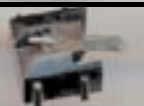
JVC NIVICO JAPAN VICTOR

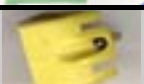
Original Stylus Number	Original Cartridge Number	Cart-ridge Type	Stylus Tip	Tracking Force	Colour	Diagram	STYLUS		Price Code
							No.	or use:	
DT52	CS1007DD	CE	SR/78 SR/2	4.0g	Black		450/78 450/2		C C
DT7	31276, SCC3	CE	SR	6.0g	Gold		325		C
DT12	MD1002	MM	C	3.5g	White		1217		I
DT16	HMD1004	MM	C	3.5g	White		165		I
DT20	HMD1008	CE	C	3.5g	Nickel		568		F
DT21H	HMD1009	MM	C	3.5g	Blue		165		I
DT23	CS1023M	CE	C	3.0g	Black		596		I
DT25H	MD1011	IM	C	2.2g	Red		7600		I
DT26	CS1026DM	MM	C	2.5g	White		7160		I
DT27	MD1012Z	IM	C	3.0g	White		504		I
DT29	MD1013Z	MM	C	3.0g	TrRed		505	1143	I
DT30S	MD1015	MM	C	2.0g	LtBlue		7140		I
DT31		VM	C	4.0g	Grey		197		I
DT32	MD1017Z	MM	C	3.0g	LtGreen		534		I
DT33H DT33S DT33G	MD1016	MM	C	1.8g	Yellow Green Black		506		I
DT34S DT34E	MD2E	MM	C E	1.8g 1.8g	Black Black		7150 715E		I J
DT35	MD1029	VM	C	2.0g	Yellow		197		I
DT36	MD1032	MM	C	2.0g	Red		1060		I
DT37L	MD1034	VM	C	1.5	Violet		1148		J













JVC NIVICO JAPAN VICTOR

Original Stylus Number	Original Cartridge Number	Cart-ridge Type	Stylus Tip	Tracking Force	Colour	Diagram	STYLUS		Price Code
							No.	or use:	
DT38		VM	C	2.0g	Red or Yellow		1071	1090	I
DT39E		VM	E	1.8g	Black		1165E		J
DT41	MD1041	IM	C	1.5g	Blue		1157		I
DT45 DT45E	MD1045	VM VM	C E	1.3g 1.3g	DkBlue or Ivory Ivory		1177 1177E		J K
DT50	CS1031	CE	C	5.0g	Yellow		6800		I
DT51	CZ680/9	CE	C	5.0g	Black		1022	1055	F
DT55 DT55/II DT55/W	MD1055	VM VM VM	C C C	2.0g 1.8g 3.0g	Yellow Yellow Red		1155 1155 1155		J J J
DT56		VM	C	1.8g	Black		1168		J
DT57		VM	C	1.3g	Ivory		1177		J
DT58		VM	C	2.5g	Blue		1155		J
DT59 DT60		VM VM	C C	2.5g 3.5g	Green or Yellow LtGrey		1304 1304		J J
DT62		MM	C	1.8g	TrBrown		1129	1163	I
DT201 DT201B		VC VC	C C	1.4g 1.3g	Blue Blue		1239MC 1239MC		L L
DTX1/II DTX1/IIIE	X1/II X1/IIIE	MM MM	C E	1.5g 1.5g	TrClear TrBrown		7170 7170E		I J
DTZ1S DTZ1E DTZ3E	Z1S Z1E Z3E	MM MM MM	C E E	1.8g 1.8g 1.8g	Grey TrOrange TrRed		6220 6220E 6220E		I J J
DTZ5S	Z5P	MM	C	1.3g	TrOrange		1252		I
DTZLS	LD77Z	MM	C	2.0g	Blue		1176		I
		MM	C	2.5g	Red		1184		I

JVC NIVICO JAPAN VICTOR

Turntable/System No	Stylus No	Turntable/System No	Stylus No	Turntable/System No	Stylus No
4TR990	596	JKA20	7170	MF23R	1022
2000	1184	JLA1, 3, 5	506	MF25	6800
5240	504	JLA10	1071	MF33R, 55/II	1060
ALA1, 151	1177	JLA11,15,20,31,35,40,45,55	6220	MF47,55LS,232,1845R	506
ALE1, 2	1155	JLA200, KLA200, KLE300	1155	W1,2,3,5CD W300,400	1155
ALE31, 33	1304	JLF30, 35, 40, 45, 50	6220	W500, 700, 900	1177
ALE300, 700	1155	L1, LA2A	1177	MSC501, MSL501E	568
ALF3, 30, 350	1177	L566	6220	Pulstar55	6220
ALFQ555	1177	LA10, 100, 110, 120	1155	QL8, 444	548QD
AS3	1060	LA11,21,31,41,55,56,66	6220	QLA2, 5, 7, 51	6220
CLS130, 135	325	LAX3, LAX 11B	1155	QLA200	1155
CS1023ED	568	LC50	1177	QLF6, 35, 61	6220
D10, 11, 22, 66, 201	6220	LE3, 5U	1148	QLF300, 320; QLFX5	1155
DC33	1155	LE20B, 22, 33, 50, 300	1177	QLF350,QLG90B,QLL2A	1177
DF19E	583QD	LE20BA	7600 or 1252	QLL777, QSL777	506
FRD45	1071	LE30BA	1168	QLY3, 5F	6220
G5-1/7, 201, 301, 303	548QD	LF66	6220	QLY33F	1217
G30	6220E	LF71	1164E	R330, 350	1177
G444, 505, 707	548QD	LF210; LFX4, 5	1155	SCP471, SSL46EA	568
GR330	6220	LR10	1071	SCR700	165
GX100, 200, 300, 400	6220	LR11, 21, 31	6220	SRBP40E	505
GX120, 222, 240	1155	LS11	1060	W33, 34	1155

KENWOOD TRIO

Original Stylus Number	Original Cartridge Number	Cart-ridge Type	Stylus Tip	Tracking Force	Colour	Diagram	STYLUS		Price Code
							No.	or use:	
N6AT	V09	MM	C	3.0g	White		165		I
N08	V08	MM	C	2.5g	Grey		7380		I
N11	DM11	VM	C	2.0g	Yellow		608		I
N15/II	F15/II	MM	C	1.5g	White		1027	1029	I
N20	T14-20	MM	C	2.5g	White		7190		I
N23	V23, T14-23	MM	C	3.5g	Grey		512		I
N25	T14-25	MM	C	2.5g	Grey		7210		I
N30	T14-30, V30	MM	C	3.0g	Grey		7210		I
N26	V26	MM	C	1.5g	Black		1015		I
N31	T14-31, V31	MM	C	3.5g	Black		7220		I
N32, 33	V32, 33	VM	C	2.5g	Grey		197		I
N34	V34	MM	C	3.0g	TrBlue		518		I
N35	V35	MM	C	2.5g	Yellow		162		I

KENWOOD TRIO

Original Stylus Number	Original Cartridge Number	Cart-ridge Type	Stylus Tip	Tracking Force	Colour	Diagram	STYLUS		Price Code
							No.	or use:	
N36	V36	MM	C	3.0g	DkGrey		7210		I
N37	V37	MM	C	3.0g	Red		7220		I
N38	V38	MM	C	3.0g	Purple		492		I
N39	V39	MM	C	2.0g	Orange		523		I
N39/II	V39/II	MM	C	2.0g	Black		6450		I
N39/III	V39/III	MM	C	2.0g	Black		1056		I
N40 N41A N42	V40 V41A V42	VM VM VM	LC C LC	2.0g 2.0g 2.5g	Ivory Yellow Ivory		525QD 197 525QD		L I L
N43	V43	MM	C	2.5g	Orange		524		I
N44	N44	MM	SH	2.5g	Blue		555QD		L
N45	V45	IV	C	2.0g	Black		6750		I
N46	V46	MM	C	1.5g	Blue		6250		I
N47	V47	MM	C	2.0g	Blue		6260		I
N48	V48	MM	C	2.0g	Yellow		608		I
N49	V49	MM	C	2.0g	Orange		1015		I
N50 N51	V50 V51	MM MM	C C	1.5g 1.5g	Black DkBlue		1139 1139		I I
N51/II		MM	C	1.5g	Orange		1190		I
N52	V52	VM	C	2.5g	Red		1071		I
N53	V53	IM	C	2.5g	Black		1144		I
N54	V54	MM	C	1.5g	Blue		1219		I

KENWOOD TRIO

Original Stylus Number	Original Cartridge Number	Cart-ridge Type	Stylus Tip	Tracking Force	Colour	Diagram	STYLUS		Price Code
							No.	or use:	
N56		VM	C	1.5g	Blue		1148		J
N59	V59	MM	C	1.25g	Grey		1242		I
N 61	V61	MM	C	1.25g	Blue or Red		1179		I
N62	V62	MM	C	1.25g	Blue		1256		I
N63		VM	C	1.3g	Ivory		1177		J
N64		VM	C	2.2g	Black		1181		J
N65	V65	MM	C	2.5g	Green		1258		I
N66	V66	MM	C	2.5g	Red		1224		I
N67	V67	MM	C	2.2g	Red		1288		I
N68	V68	MM	C	1.25g	Red		1241		I
N69	V69	MM	C	1.8g	Orange		1183		I
N72	V72	IM	C	3.0g	Orange		1179		I
N74		VM	C	2.0g	Yellow		1155	1167	J
N75		VM	C	2.5g	Black		1168		J
N76		MM	C		Red		1299		I
N77			C		Black		1308		J
N78		VM	C		Yellow		1304		J

KENWOOD TRIO

Turntable/System No	Stylus No	Turntable/System No	Stylus No	Turntable/System No	Stylus No
KD7X, 33F	1139	KD491	1288	P3SX	1179
KD9X	1144	KD550	6250	P5	1181
KD12R,21R,22R,31R,32R	1219	KD650, 750	608	P5D	1144
KD26R	1177 or 1241	KD747	1181	P5X,P71	1288
KD29R	1304	KD1022	6450	P7	1139
KD34R, 35R	1181 or 1256	KD1500, 1600, 2100	1056	P26	1155
KD36R,37R,38R,48,49F	1288	KD2000,2070,3000,4000	6260	P24, 28, 29	1308
KD38, 39R	1155	KD2005,2022,3022,5022	523	P28T	1224
KD40R,44,50,55F	1139	KD2021, 3021, 4021	518	P31,110	1299
KD41R,42R,51,52F	1071	KD2022, 3022	518 or 523	P42, 43, 55	1224
KD47	1241	KD2033,2055,3033,3055	6450	P66	1308
KD54R, 55R	1256	KD3100,3070,4100,5100	6450 or 1056	P83	1288
KD64F, 65F	1177	KD4020, 5010	1155	P94	N71
KD66, 67, 68	1288	KD5033	6250	P100	1304
KD72F	1148	KD5066	197	P235, PC235	1308
KD74F	1242	KD5070	608	PC100, 250	7220
KD75F	1181	KP5022	197 or 523	PC350, 400	7210
KD112R,122R	1219	KS100C,200C,300,400	1056	PM30	1179
KD211R	1071	KS3000, 4000	6260	RXD25L	1155
KD291R	1155	LD21R,41R,51R	1071	ST5J	492
KD300, 1033	6260	M30	1288	ST5V	197















KNEEBENT

Original Stylus Number	Original Cartridge Number	Cart-ridge Type	Stylus Tip	Tracking Force	Colour	Diagram	STYLUS		Price Code
							No.	or use:	
Accoustic		CE	LP		Metal		6		C





KRIESLER

11-98, 101, 104, 105, 108, 109, 11-110, 112, 113, 114, 120, 122 11-123, 124, 127, 128, 129, 130 11-132, 135 A165, ET127, M187, T87A, 88A, 105, 157	CE CE	SR/2 SR/78	5.0g 5.0g	White White		88/2 88/78	442/2 442/78	C C
11-103 A118, 160, 161 RA98	CE	SR/2	4.5g	Grey or Yellow		263	332	C
11-104, 129, 131, 133, 134, 137 11-140, 154, 165, 170, 172, 177 11-179, 180, 181, 182, 188, 189 11-190, 200, 201, 202, 204, 206 11-207, 208, 209, 210, 211, 214 11-215, 216, 217, 218, 219, 220 11-221, 222, 223, 224, 225, 236 11-237, 240, 241, Disco 4000	CE CE	SR/2 SR/78	4.5g 4.5g	Black Black		444/2 444/78		C C
11-107, 115, 116	CE	SR		Gray or Yellow		369		C
11-116	CE	SR/2		Black or White		97		C
11-120, 132, 135, 138, 140, 144 11-150, 151, 153, 154, 155, 165, 11-166, 167, 169, 170, 172, 180 11-181, 182, 185, 186, 187, 191 Powersound 515, Disco Tape	CE	SR/2		Yellow or Red		464		C
11-122, 133, 142, 146, 147, 149 11-160, 163, 168, 171, 192, 193	CE CE	SR/2 SR/78	7.0g 7.0g	White or Grey White or Grey		404/2 403/78		C C
11-118, 125, 126	MM	C	1.5-3.0g	White		387	424	I

KRIESLER

Original Turntable or System Number	Cart-ridge Type	Stylus Tip	Tracking Force	Colour	Diagram	STYLUS		Price Code
						No.	or use:	
11-125, 126, 152, 156 11-158, 159, 167	MM	C	2.5g	Blue		170		I
11-132B	CE	C	4.5g	Black		570		F
11-134, 137, 143, 146 11-148, 149, 161	CE CE	SR/78 SR/2	5.0g 5.0g	White White		442/78 442/2	88/78 88/2	C C
11-159	MM	C	3.5g	White		165		I
11-235, 236, 239, 246 Q4 Disco	CE CE	SR/2 SR/78	4.5g 4.5g	White White		475/2 475/78	499	C C
11-242, 244 Q4-Disco	MM	C	2.3g	Black		6870		I
11-301	CE	C		Grey		453		F
11-302, 310	CE	C		Black		1022	1055	F
11-400, 401, 402, 403, 405, 410 11-412, 501 51-102, 510-66, 86 500 Slimline	MM	C	2.5g	Blue		579		I
89-112	CE	C		Black		1055	1022	F
KS2 MC8200 RP1	MM	C	1.5-2.0g	TrGreen		1197		I
Disco Tape	MM	C	3.0-5.0g	Light Blue		498		I
RP3	MM	C	1.8g	Black		1081		I
RP4	MM	C	2.0g	Clear		1170		I



LENCO

N70	M70	MM	C	2.25g	Beige		414	498	I
N75	M75	MM	E	2.25g	Yellow or Black		456E		J
N94	VM95P M94	MM	C	1.75g	Red		120		I
N100	M100	MM	C	2.5g	Blue		170		I
N150	M150	IM IM	C E	2.75g 1.5g	Lilac Beige		130 130E		I J
		MM MM	C E	1.25g 1.25g	Red Yellow		186 186ED		I J



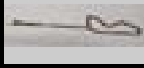

LENCO

Turntable/System No L20, 65, 78 L80, 82, 84	Stylus No 186 or 414 170	Turntable/System No L90, 660 L350, 830, 833	Stylus No 414 170	Turntable/System No L930, 4000	Stylus No 414
----------------------------------------------------------	---------------------------------------	----------------------------------------------------------	--------------------------------	------------------------------------------	-------------------------



LESA

Original Stylus Number	Original Cartridge Number	Cart-ridge Type	Stylus Tip	Tracking Force	Colour	Diagram	STYLUS		Price Code
							No.	or use:	
U2		CE	SR/2		Metal		309		C
W		CE	SR/2		Grey		373		C

LINEAR DESIGN

DP200		MM	C	2.2g	Orange		7450		I
DP320		MM	C	2.2g	Red		552		I
DP330, 350		VM	C	3.0g	Beige		197		I
GST1, 2		MM	E	1.3g	Yellow		425E		J
LD500,P500		MM	E	2.2g	LtGreen		6890EJ		J



LUXMAN

IMS155E PD284		MM	C	1.5g	Black		1036		I
PD290						This stylus is no longer available, recommend new MM cartridge	1126		
PD291						This stylus is no longer available, recommend new MM cartridge	881		
PD264		MM MM	C E	2.0-5.0g 2.0-5.0g	Grey Grey		100 100E		I J
PDT264		VM	C	2.0g	Yellow		1070		I

MARANTZ

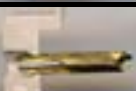
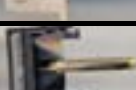

Original Stylus Number	Original Cartridge Number	Cart-ridge Type	Stylus Tip	Tracking Force	Colour	Diagram	STYLUS		Price Code
							No.	or use:	
CT4S, 6120	TT4, 6120	MM	C	2.2g	Red		569		I
CT5S, 250 CT1020, 1200 CT2020, 2200 CT4200, 6200	TT5, 250 TT1020, 1200 TT2020, 2200 TT4200, 6200	VM	C	2.5g	Red		1071	1090	I
CT6S CT300	TT6S TT300	VM VM	E C	2.0g 2.0g	Green or Blue Yellow		1085E 1070		J I
CT42	TT42	VM	C	2.0g	Yellow		1155		J
CT100, 120	TT100, 120	MM	C		TrSmoke		1253		I
CT121	TT121	MM	C	1.5g	TrGreen		1172		I
CT130, 134 CT221, 320 CT321, 420 CT500, 3200 CT140, 165	TT130, 134 TT221, 320 TT321, 420 TT500, 3200 TT140, 165	MM	C	2.5g	Black or Red		1184		I
CT170, 185 CT240, 340 CT430, 440 CT451, 2462	TT170, 185 TT240, 340 TT430, 440 TT451, 2462	VM	C	1.3g	White		1177		J
CTS143, 243 CT253, 353	TT143, 243 TT253, 353	VM	C	1.5g	Black		1181		J
CT151, 251 CT351, 451 CT551Old, 553	TT151, 251 TT351, 451 TT551, 553	MM	C		Blue		1259		I
CTS153, 173 CT230, 253	TT153, 173 TT230, 253	MM	C	1.25g	Orange		1129	1163	I
CT285, 873	TT285, 873	VM	C	2.0-2.5g	Black		1168		J
CT333, 433 CT443, 533 CT553	TT333, 433 TT443, 533 TT553	VM	C	1.5g	Black		1187		J
CT320	TT320	MM	C		TrGreen		1151		I
CT440, 520 CT521, 525 CT530	TT440, 520 TT521, 525 TT530	MM	C	1.25g	Blue		1203		J
CT483	TT483	IM	C	1.25g	Black		1278		I
CT493	TT493	MM	C		Red		1299		I
CT530	TT530	IM	C	1.25g	Clear		1215		J

MARANTZ





Original Stylus Number	Original Cartridge Number	Cart-ridge Type	Stylus Tip	Tracking Force	Colour	Diagram	STYLUS		Price Code
							No.	or use:	
CT551New	TT551	MM	C	1.25	DkBlue		1290		I
CT2000, 4000 CT6000, 6025 CT6110, 6150 CT6170	TT2000, 4000 TT6000, 6025 TT6110, 6150	VM VM	C E	2.5g 2.0g	Yellow Green		608 608E		I J
CT2000, 4000 CT4000, 6000 CT6110, 6150 CT6170	TT2000, 4000 TT2000, 6000 TT6110, 6150 TT6170	MM MM	C E	1.5-3.0g 1.5-3.0g	Beige Green		689 689EJ		I J
CT6350	TT6350	MM	E	0.75-1.25g	Black		541E		J

Turtable/System No	Stylus No	Turtable/System No	Stylus No	Turtable/System No	Stylus No
TT42	1155	TT285	1168	TT530	1203 or 1215
TT100, 120	1253	TT300	1070	TT533	1187
TT121	1172	TT320	1151 or 1184	TT551 Old	1259
TT130, 134	1184	TT321	1184	TT551 New	1290
TT140	1177	TT333	1187	TT553	1187 or 1259
TT143	1181	TT340	1177	TT873	1168
TT151	1259	TT351	1259	TT1020, 1200	1071
TT153	1129	TT353	1181	TT2000	608 or 689
TT165, 170	1177	TT420	1184	TT2020, 2200	1071
TT173	1129	TT430	1177	TT2462	1177
TT185	1177	TT433	1187	TT3200	1184
TT221	1184	TT440	1177 or 1203	TT4000	608 or 689
TT230	1129	TT443	1187	TT4200	1071
TT240	1177	TT451	1177 or 1259	TT6000,6025,6110	608 or 689
TT243	1181	TT483	1278	TT6120	569
TT250	1071	TT493	1299	TT6150, 6170	608 or 689
TT251	1259	TT500	1184	TT6200, 6300	1071
TT253	1129 or 1181	TT520, 521, 525	1203	TT6350	541E









MASTERCRAFT

SJN1	Singer	CE	C	6.0g	Grey		400		C
SMC101	V40	MM	C	3.0g	Grey		1326		I
MC1-5		MM	C	3.0g	White		512		I

MICRO

VP1 V5 V8 V10 V70	PLAS1 LM5 LM8, LM12 SCM10 LM70	MM	C	1.0-2.0g	Black		1074		I
V20	LM20	MM	C	1.2g	Black		1311		I
V52		IM	C	3.0g	Red		1179		I
V120, 201		CE	Stereo	6.0g	Metal		325		C

MICRO

Original Stylus Number	Original Cartridge Number	Cart-ridge Type	Stylus Tip	Tracking Force	Colour	Diagram	STYLUS		Price Code
							No.	or use:	
V207	C2, M207	MM	C	3.5g	White		200		I
V307	C307	IM	C	2.0g	Blue		1018		I
V1110	VF1110	MM	C	2.2g	LtGreen		539		I
V2100/5 V2100/6	M2100/5 M2100/6, 7	MM MM	C C	1.5g 2.0g	Red Red		162 162		I I
VV3100/5	VF3100/5	MM	C	1.75g	White		502		I
V3200/5	VF3200/5	MM	C	1.75g	Red		576		I
V3300/7	VF3300/7	MM	C	2.0g	Black		6360		I
50PE		IM	C	1.25g	Clear		1215		J



mitsubishi

SJN16		CE	SR	6.0g	Nickel		175		C
SJN18		CE	SR	5.0g	White		516		F
3D-20		CE	SR	6.0g	Gold		325		C
3D-23, 24M	DMC6001	MM	C	2.5g	White		200		I
3D-25	DSS5000	CE	C	4.0g	White		6900		I
3D-28	DMC28	MM	C	1.75g	White		502		I
3D-29	CRM350	CE	C	4.0g	White		7250		I
3D-31M	SLD5500	CE	C	3.5g	LtGreen		7270		I
3D-30M	DMC2100	MM	C	3.0g	LtGreen		7260		I
3D-32	CRM450	CE	C	4.0g	Nickel		568		F
3D-33M	DMC8700	MM	C	3.0g	LtGreen		1143	505	I

MITSUBISHI

Original Stylus Number	Original Cartridge Number	Cart-ridge Type	Stylus Tip	Tracking Force	Colour	Diagram	STYLUS		Price Code
							No.	or use:	
3D-34M	DMC2200	MM	C	3.0g	LtGreen		545		I
3D-35M	MAG35	CE	C	5.0g	White		516		I
3D-37M	MAG1	MM	C	2.0g	Beige		6930		I
3D-38M	MAG2	MM	C	2.0g	DkGreen		6940		I
3D-40M	MAG3	VM	C	2.0g	Grey		197		I
3D-42M	MAG42	VM	C	2.0g	Yellow		608		I
3D-43M		MM	C	2.0g	Red		1097		I
3D-44M	MAG4	MM	C	2.0g	Black		1019		I
3D-45M	MAG45	VM	C	2.0g	Red		608		I
3D-46M	MAG46	MM	C	2.0g	Red		1097		I
3D-47M		VM	C	2.0G	Yellow		1071	1090	I
3D-48M	DGH8700	MM	C	3.0g	Beige		1143	505	I
3D-50M	MAG50	MM	C	1.5	Black		1192		I
3D-51M		VM	C	2.0g	Black		1168		J
3D-52M		VM	C	2.0g	Blue		1227		J
3D-54M		VM	C	1.5g	Black		1187		J
3D-55M		VM	C		Black		1168		J
3D-56M		VM	E	1.3g	Black		1177E		K
3D-57M		VM	C	1.3g	Black		1177		J
3D-MM1	MM1	MM	C	1.75g	Black		552		I







MITSUBISHI

Original Stylus Number	Original Cartridge Number	Cart-ridge Type	Stylus Tip	Tracking Force	Colour	Diagram	STYLUS		Price Code		
							No.	or use:			
3D-MM2	MM2	MM	E	2.0g	Black		1229E		J		
3D-LT55		MM	C	2.0g	Blue		1258		I		
TR2		CE	C	5.0g	Black		179		F		
Turntable/System No		Stylus No		Turntable/System No		Stylus No		Turntable/System No		Stylus No	
DP84, 210, 300, 2000 DP200 DPX10		608 6930 1143 or 1071		E804CD, EGD60R LT41, 43 LT45, 47, 70		1155 1192 1187		LTP100, 604, 703, 804 LTP603 MD717, 9613		1187 1179 608	

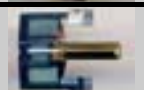
MORSE

M725 RP1220 TS718, 1100, 1200	MM	C	2.5g	Red		1184			I
RP1120	IM	C	3.0g	Red		1179			I
TS20, 2297	CE	C	3.0g	Blue		594	164		I
TS40, 7150	CE	Stereo		White		1132			C
TS725	VM	C	2.0g	Yellow		1155			J
TS1000	IM	C	4.0g	DkGrey		1093			I

NAGAOKA

JN311	JT311	MM	C	1.2-2.0g	LtGreen		6170			I
JN321B JN321EB	MM321B MM321EB	MM MM	C E	1.5-2.0g 1.5-2.0g	TrGreen TrGreen		1197 616E	616		I J
JN322 JN333	JT322 JT333	MM MM	C Shibata	1.2-2.0g 1.1-1.5g	LtGreen White		6170 6190QD			I L
JN451	JT451	MM	C	3.0g	Blue		1243	1208		I
JN511 JN555	JT511 JT555	MM	C	1.1-1.5g	TrBlack or Red		1010			I
JN711	JT711	MM	C	1.5g	Black or TrGreen		1036			I
N05MP	MP05	MM	C	1.5-2.0g	Red		1161			I

NAGAOKA

Original Stylus Number	Original Cartridge Number	Cart-ridge Type	Stylus Tip	Tracking Force	Colour	Diagram	STYLUS		Price Code
							No.	or use:	
N10MP N11MP N15, 20MP	MP10 MP11E MP15, 20	MM MM MM	C E E	2.0g 2.0g 2.0g	Brown Beige Beige		1236 1236E 1236E		J K K
N11A	NM11A	MM	C		Gold		1020		I
N22	NM22	MM	C		White		1021		I
N33	NM33	MM	C	3.5g	White		165		I
N51/II, 501MP N51E/II N51/II-78	C51M/II, C501M C51E/II C51M/II-78	MM MM MM	C E 78rpm	1.8g 1.8g 1.8g	Orange Blue Orange		1190 1190E 1190-3		I J J
N100, 200 N300	OS100, 200 OS300	MM MM	C	1.8g	TrBrown		1220		K
N320		MM	C		TrGreen		1151		I









NATIONAL—PANASONIC—TECHNICS

EPS04	EPC29, 69	CE	Stereo	6.0g	Metal		325		C
EPS 05, 06	ST602, 605	CE	Stereo	5.0g	Nickel		407		C
EPS08, 10, 12	EPC83 SC580, 581	MM	C	2.0-4.0g	Black		515		I
EPS11	EPC81, 95	CE	Stereo	3.5g	Nickel		611		F
EPS13	EPC34TTAD	CE	Stereo	4.5g	Black		570		F
EPS14	EPC34STAD	CE	Stereo	4.5g	Black		177		F
EPS18	EPC42	CE	Stereo	3.0g	Grey		613		F
EPS17, 19	EPC40	CE	Stereo	4.0-5.0g	Black		178		F
EPS21, 22	CS1025	CE	Stereo	3.0-4.0g	Nickel		568		F
EPS23, 24CS EPC23, 24ES	EPC-P23, 24 EPC-P23, 24	MM MM	C E	1.5-2.0g 1.5-2.0g	TrOrange or Blue TrOrange or Blue		1163 1141E	1129	I J
EPS24	EPC95SSED	CE	Stereo	3.0g	Nickel		517		F

NATIONAL PANASONIC TECHNICS

Original Stylus Number	Original Cartridge Number	Cart-ridge Type	Stylus Tip	Tracking Force	Colour	Diagram	STYLUS		Price Code
							No.	or use:	
EPS25	EPC42STAD	CE	C	3.25g	Grey		516		I
EPS25CS EPS25ES EPS27CS	EPC-P25 EPC-P25 EPC-P27	MM MM MM	C E C	1.75g 1.75g 1.75g	TrBrown TrBrown TrYellow		1129 1141E 1129		I J I
EPS27	EPC09STA	CE	C	4.5g	White		1112		I
EPS28	EPC96SSAD	CE	C	3.25g	Yellow		614		I
EPS28ES	EPC-P28	MM	E	1.75g	TrYellow		1141E		J
EPS30, 31		VM	C	2.0g	Yellow		197		I
EPS30, 33CS EPS30, 33ES	EPC-P30, 33 EPC-P30, 33	MM MM	C E	1.0g 1.0g	Blue Blue		1221 1222E		I J
EPS34CS	EPC-P34	VM	C	1.3g	White or Black		1177		J
EPS34STSD EPS35STSD EPS35STED EPS35STCS		VM VM VM VM	C C E C	3.0g 2.0g 1.5g 1.7g	Grey Red Blue Yellow		197 197 1004E 197		I I J I
EPS36STSD	EPC05STA	CE	C	6.0g	White		6290		F
EPS37	EPC07	CE	C	4.5g	White		1154		I
EPS39STSD		VM	C	4.0g	Grey		608		I
EPS41STSD	EPC41	CE	C	4.0g	Red or White		1153		I
EPS43STSD		VM	C	3.2g	Grey		1155		J
EPS46STSD EPS46STQD	EPC451C EPC460CIV	MM MM	C SH	3.5g 2.5g	Yellow White		157 535QD		I L
EPS51CS	EPC-P51	MM	C	1.25g	Red		1129	1163	I
EPS52 EPS53STED EPS56	EPC86MAD EPC88SMAD EPC79MAD	MM MM MM	C E C	2.25g 1.75g 3.5g	TrOrange Clear Blue		158 616E 7280	616	I J I
EPS74STSD EPS74STED		VM VM	C E	2.0g 1.7g	Yellow Blue		608 608E		I J
EPS75STSD		VM	C	2.5g	Red		1071		I



NATIONAL PANASONIC TECHNICS

Original Stylus Number	Original Cartridge Number	Cart-ridge Type	Stylus Tip	Tracking Force	Colour	Diagram	STYLUS		Price Code
							No.	or use:	
EPS76STSD	EPC76SMAD	VM	C		Yellow		1070		I
EPS90STED EPS90STGD		VM VM	E C	1.3g 1.3g	Green Grey		1302E 1191		K J
EPS91SMD		VM	C	1.3g	Ivory		1177		J
EPS202 EPS202ED	EPC202 EPC202	MM MM	C E	1.0-1.5g 1.0-1.5g	Clear Clear		1163 1141E		I J
EPS205 EPS205E EPS206C EPS207ED		MM MM MM MM	C E E E	1.0-1.5g 1.0-1.5g 1.5-2.0g 1.5-2.0g	Black Gold Black Black		7300 1083E 1083E 1083E		I J J J
EPS270 EPS270ED EPS290	EPC270D EPC270C/II EPC290C	MM MM MM	C E C	1.5-2.0g 1.5-2.0g 2.5g	TrGreen TrGreen TrOrange		616 616E 158		I J I
EPS451	EPC451	MM	SH	2.0-3.0g	Red		535QD		L
EPS510CS EPS520ES	EPC-P510 EPC-P520	MM MM	C E	1.25g 1.25	Green Blue		1129 1141E	1163	I J
EPS530ES EPS540ES EPS550ES	EPC-P530 EPC-P540 EPC-P540	MM MM MM	E E E	1.25g 1.25g 1.25g	Grey Gold/Black Red/Gold		1222E 1222E 1222E		J J J
Turntable/System No	Stylus No	Turntable/System No	Stylus No	Turntable/System No	Stylus No				
CSL130/5 FG521, 740DU K44 LED1500 Local 440 MSL110 P440, Phoenix R112 RD660, 3500, 6500 RE7014 RS2571S RS3000 SAP829 SC120 SC130, 140, 220 SC8500DX SCD4 SCK3, 7 SDG16 SE15, 25, 40, 53A, 840 SE55, 900H, 9000 SE5050, 5070, 5757 SF155 SF165 SF170, 175 SF520 SF6600 SG27, 35, 38, 55, 62, 65 SG68, 88, 123, 207, 245 SG100, 106, 110, 151, 155 SG180, 310, 333, 338, 345 SG152, 235	325 325 1071 1153 444 or 475 325 1155 1163 616 475 570 516 197 or 614 515 177 157 1129 1129 1153 325 515 157 178 177 515 325 616 570 570 570 325 325 325 325 325 325 325 325 325 1155	SG300 SG305, 306 SG410 SG548E, 567, 725, 740 SG550 SG650, 770, 820 SG747AP SG760, 766 SG825 SG945 SG950 SG970, 990, 1008, 1050 SG1000, 1030, 1060 SG1005, 1010, 1020 SG1070, 1170 SG1100, 1260F SG1230F, 1260S SG1410 SG1500 SG1800 SG2050, 2080 SG2230, 2650, 5700 SG2800 SG3000, 3060, 3090 SG3600, 7500 SGD10, 16, 20, 25 SGD35 SGD1660 SGJ300, 500, 555, 600 SGR1125 SGV03, 07 SGV05	729QD 1090 1112 325 1071 407 475 325 or 178 570 178 517 570 6290 325 6290 475 570 1112 1153 6290 or 1112 197 570 7280 616 158 1153 1153 1153 1163 1153 1129 or 1155	SGW3 SGX15 SH350, 530 SH900H, 9000 SKMA1035 SL02, 03, 15 SL3, 5, 7, 310 SL6 SL19, 20, 22, 23 SL29A, 31, 41, 42 SL29D SL120, 303 SL200, 210, 211, 1300 SL220, 221, 230, 231, 235 SL701, 750, 770, 880 SL1200/II, 1300/II, 1400/II SL1401A, 1500, 1600 SL1500/II, 1600/II SL1650, 1700, 1800 SL1700/II, 1800/II SL1900, 2000 SL2050, 2080 SL2200, 2800, 3060, 3100 SL3200, 3300, 3310, 3350 SL3500, 7500 SL5100, 5200, 5300 SLB2, 3, 31, 202, 210, 212 SLB20, 21, 30 SLB25 SLB303 SLB2002, SLBD20B SLBD20, 22K	1153 1153 177 515 1129 7300 1129 1099 616 197 515 158 616 616 or 1129 157 7300 616 7300 616 6230E 616 197 616 616 7300 1129 1177 515 1129 1129 1177				

NATIONAL PANASONIC TECHNICS

Turntable/System No	Stylus No	Turntable/System No	Stylus No	Turntable/System No	Stylus No
SLD1, 2, 3	616 or 1129	SLN5, 15, 25	1129	SS3040	332
SLD4	1163	SLQ2	1129	SS4010	570
SLD20, 21, 30, 31	1129	SLQ3	6230E or 1221	SS4025, 7000, 7100	197
SLD33	616 or 1129	SLQ300, 303	1221	SS4600, 7500, 7540	158
SLD51, 202, 210, 212	1129	SLQD3, 33	1221	SS7020, 7030, 8030J	516
SLD303	1129	SLQL1, 15	1163	SS7700, 7800	157
SLDL1, 5	1163	SLQL5	1221	SS8020, 8030L	197 or 613
SLF1	1221	SLQX200, 300	1221	SS8060	517
SLF11	1129	SLV5	1163	VX900,920,930,950	1129
SLH303, 401	616	SLX25, 85, 230, 800	1129	VX980	1129
SLHM42	1153	SLX830	1129	VZ78, 300, 780, 900	1129
SLJ1, 2, 3	1221	SLZ190	1129	VZ920, 930, 950, 980	1129
SLJ11, 90, 100, 110	1129	SM2670	197	Z190,780,980,1125	1129
SLJ515	1129	SQ3000	729QD	Z3025,3525,3526	1129
SLJS1, 2, 3, 16	1221	SS1000,1100,1200	157	Z5525, 6555	1221
SLL20	1221	SS2100, 2500, 2900	157	Zigma300, 500, 2400	1129
SLM1	1221	SS2800	387	Zigma R150, 190, 290	1129
SLM5	6230E	SS3010, 8010	325	Zigma Z700, 990	1221

NEAT

Original Stylus Number	Original Cartridge Number	Cart-ridge Type	Stylus Tip	Tracking Force	Colour	Diagram	STYLUS		Price Code
							No.	or use:	
DS40	V40	MM	C	3.0g	Grey		1326		I
ND70 ND705, 707	VC70 VS705, 707	MM MM	C C	3.0g 3.5g	Ivory Red		486 486		I I
N800	V800	MM	C	2.5g	Blue		170	171	I





NEC

LP10D		MM	C	2.0g	Black		515		I
LP15		CE	SR	6.0g	Metal		325		C
LP20D	NS810, 812	MM	C	7.0g	White		165		I
LP25D	NS307, 710	CE	C	7.0g	White		163		I
LP30D		CE	C	5.0g	DkGrey		7110		I
LP35D	NS815	CE	C	5.0g	Black		1022	1055	F
LP40D	NS130	CE	C	5.0g	Ivory		164	594	I
LP45D		CE	C	5.0g	Black		557		I
LP50D		MM	C	2.0g	Blue		6500		I

NEC

Original Stylus Number	Original Cartridge Number	Cartridge Type	Stylus Tip	Tracking Force	Colour	Diagram	STYLUS		Price Code
							No.	or use:	
LP55D		CE	C	7.0g	Black		194		F
LP60D		MM	C	2.5g	Grey		1143	505	I
LP65D		MM	C	2.0g	White		6260		I
LP70D		MM	C	3.0g	Orange		1086		I
LP75D		MM	C	2-2.5g	Red		1060		I
LP305D		MM	C	1.5-2.0g	Blue		1185		I
LP310		MM	C	2-2.5g	Orange		7730	7480	I
LP335		VM	C	2.5g	Red		1071	1090	I
LP444		VM	C	1.3g	Blue		1177		J
LP560D		VM	C	1.3g	Grey		1191		J
LP600, 6000 LP735		VM	C	3.5g	Yellow or Blue		608		I
LP5100		MM	C	2.5g	Beige		564		I
LP6100 LP6300		MM	C	2.0g	Red		539		I
LP6800		MM	C		Red		1096		I
LP7000D		VM	C	4.0g	Red		197		I
LP8000D		VM	E	3.0g	Green		1004E		J
LP8300D		MM	C	2.5-4.0g	Red		569		I
CR1971		MM	C	2.5g	Red		1208	1243	I
MC310		CE	C	4.0g	Red or White		1153		I
MC320		CE	C	6.0-7.0g	Grey or Red		1279		I

NEC

Original Stylus Number	Original Cartridge Number	Cartridge Type	Stylus Tip	Tracking Force	Colour	Diagram	STYLUS		Price Code
							No.	or use:	
MC510		MM	C	2.5g	Red		1190		I
		MM	E	2.5g	Blue		1190E		J
MC570 MC571		VM	C	2.5g	Yellow		1155	1167	J
NS810		IM	E	0.5-1.25g	Black		6950E		J
		IM	C	1.0-1.5g	Black		6950		I
P420		IM	C	3.0g	Red		1179		I

Turntable/System No	Stylus No	Turntable/System No	Stylus No	Turntable/System No	Stylus No
A110E CR1971 MC225, 253, 255E MC310 MC320 MC330 MC335 MC370 MC510 MC570, 571	1185 1208 1022 1153 1279 1226 1022 1226 1190 1155	NPS222 NPS240 NS130 NS307, 710 NS810 NS812 NS815 NS1300 P305E P335	163 165 164 163 6950E 165 1022 164 1185 1071	P420 P435 P635 P645E P735 P745E System 21 System 33 System 45 System 1026	1179 1071 608 1179 608 or 1071 1179 1185 1179 1179 1153





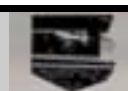

NEOTECH

STW17J		MM	C		Red		1299		I
--------	--	----	---	--	-----	--------------------------------------------------------------------------------------	------	--	---



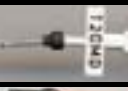



NIKKO

N50	NP500	MM	C	1.5g	Black		1139		I
-----	-------	----	---	------	-------	--------------------------------------------------------------------------------------	------	--	---

NOVATECH

668, HT506, 530, 531 MAG530, 725 MD200, 500XT N5100V		VM	C	2.5g	Yellow		1155		J
1120, 9000 RP529, 777, 1120, 9000, 9910		IM	C	3.0g	Red		1179		I
7150, 8060 SM32B SNT2100		CE	Stereo		White		1109		C
HT501		VM	C	2.0g	Red		1226		J
HT501A, 531V, 533 N530TQ Series 533		MM	C	1.25g	Red		1241		I
M665 MC200 MID6WD, MY32 SX4000		CE	C		Red		1260		I
MD400		VM	C	1.3g	White		1177		J

NOVATECH

Turntable or System Number	Cart-ridge Type	Stylus Tip	Tracking Force	Colour	Diagram	STYLUS		Price Code
						No.	or use:	
P232	IM	C	4.0g	Dk Grey		1093		I
RP570, 718, 1220	MM	C	2.5g	Red		1184		I
RP1220	MM	C	1.5g	Black		1036		I
SNX3000, 3100, 3500, 4000 SNX6000	CE	C	3.0g	Ivory		164	594	I
SNX7150	CE	Stereo	5.5g	Grey		1194		C
SNX8060	CE	SR/2 SR/78		White White		475/2 475/78	499	C C
TS20, 725	CE	C	3.0-4.0g	White		195		I

ONKYO

DN1	OC2, 11	CE	C	6.0g	Metal		325		C
DN3ST	OC9C	CE	SR	5.0g	Metal		407		C
DN5ST, 13ST	OC5M, 13M	MM	C	3.0g	White		165		I
DN7ST, 10ST DN17ST	OC7M, 10M OC17M	MM	C	6.0g	Grey		515		I
DN8ST, 9ST	OC9C, 20C	CE	C	4-6.0g	White		163		I
DN12ST	OC12C	CE	C	6.0g	Black		177		F
DN14ST	OC14S	CE	C	2.0g	Nickel		611		F
DN15ST	OC15	IM	C	3.5g	Green		180		I
DN16ST	OC16M	MM	C	3.0g	White		184		I
DN18ST, 24ST	OC18M, 24ST	MM	C	3.5g	Red		492		I
DN20		VM	C	2.0g	Yellow		1070		I
DN21, 22, 23	OC19, 21, 22	MM	C	2.5-3.5g	LtGreen		161		I

ONKYO

Original Stylus Number	Original Cartridge Number	Cart-ridge Type	Stylus Tip	Tracking Force	Colour	Diagram	STYLUS		Price Code
							No.	or use:	
DN25ST	OC410M	MM	QD	2.0g	TrRed		201QD	170	L
DN27, 32ST	OC27V, 32	VM	C	2.0g	Grey		197		I
DN28CD DN29, 34ST	OC28M OC29, 34M	MM MM	QD C	2.0g 2-2.5g	Yellow LtGreen		540QD 539		L I
DN30ST	OC30M	MM	E	2.0g	Black		595E		J
DN31ST	OC31	CE	C	7-8.0g	White		499	475	C
DN33ST	OC33	MM	C	2.0g	Red		552		I
DN35ST	OC35	VM	C	2.0g	Yellow		608		I
DN36ST	OC36	MM	C	2.0g	Green		508	492	I
DN37, 38ST	OC37V, 38	VM	C	1.5-2.5g	White		1101		J
DN39ST	OC39	MM	C	2.0g	Yellow		1069		I
DN40ST	OC40V	MM	C	2.0g	Black		1019		I
DN51ST	OC51M	MM	C	2.0g	Red		1135	1097	I
DN52ST	OC52M	VM	C	2.0g	Red		1071	1090	I
DN54ST	OC54	MM	C	2.0g	Orange		1159		I
DN55ST DN59ST	OC55 OCH590	VM	E	2.0g	Black		1164E		J
DN56ST	OC56	VM	C	2.0g	Grey		1293		I
DN57ST	OC57	MM	C	1.5g	Grey		1189		I
DN60STE	OC60VMS	MM	E	1.25g	Red		1029E		J
DN61, 65S1 DN61, 63STE		VM VM	C E	2.0g 2.0g	Yellow Green		1155 1155E		J K

ONKYO

Original Stylus Number	Original Cartridge Number	Cartridge Type	Stylus Tip	Tracking Force	Colour	Diagram	STYLUS		Price Code		
							No.	or use:			
DN62ST		VM	C	2.0g	Black		1168		J		
DN67ST DN70, 74ST		MM	C	2.5g	Red		1258		I		
DN68ST		VM	C	2.0g	Grey		1304		J		
DN72		MM	C	1.5-2.0g	TrBrown		1129	1163	I		
DN106	OC106	MM	C	3.0g	White		534		I		
DN107	OC107	MM	C	3.0g	Orange		504		I		
DN201ST		VM	C	2.0g	Blue		1070		I		
DN201STE		VM	E	2.0g	Blue		1085E		J		
DN1005		MM	C	2.5g	Beige		564		I		
CP1030		MM	C		Blue		579		I		
CP1116A		MM	C		Red, White or Blue		6410		I		
GP100A		MM	C	2.0g	Black		6360		I		
PL150		CE	C	4.5g	White		1154		I		
SM710		CE	Stereo		White		442/2		C		
Turntable/System No		Stylus No		Turntable/System No		Stylus No		Turntable/System No		Stylus No	
CP30M		492		CP5000A		608		Licence 2000		552 or 608	
CP55A		539		DF700		163		Licence 3000, 5000		608	
CP60A		197		DF800		564 or 161		M3		552	
CP80M		595E		Disco1000		1155		M55, 7312, 7412		608	
CP100A		608		DN72		1129		M7512, 7612		608	
CP101A		1258		EP700M		552		MC70A		161	
CP535		552		F1, 7		499		MC1500		515	
CP790		1070		GP60A		197		MC2000		184	
CP880, 890, 1028A		1164E		GP80M		595E		MC2100, 2200, 2300		165 or 180	
CP990R		1168		GP100A		6360		MC2500		180	
CP1000A		1071 or 1135		GP700		552		MC 3000, 3100, 3200		492 or 161	
CP1005A		564		GP1010, 1020A		1069		MC3400, 3500, 3600		492 or 161	
CP1007, 1022, 1026A		1155		GX3		608		Midi 05, 06		1071	
CP1010A, 1055		1069		Intec 405		540QD		Midi 08		1135	
CP1012, 1017, 1020		1135		K300, 500		539		MP1000		?	
CP1027E, 1028R		1135		Licence15		564		MSS 200, 7312, 7412		608	
CP1030		579 or 1101		Licence 22, 25		1155		MSS 7512, 7612		608	
CP1033, 1046F, 1057F		1155		Licence 31, 51, 71		1069 or 1135		PL33		1293	
CP1116A		6410 or 1258		Licence 82, 83		1164E		PL150		1154	
CP1200, 1400		1258		Licence 85, 1000		1155		PLM7		1155	

ONKYO

Turtable/System No	Stylus No	Turtable/System No	Stylus No	Turtable/System No	Stylus No
PLX1	1258	ST890, 900	515	X35, 100	492
PX55R	1155	ST6000, 7500	165	X300, 500, 700	539
Radiant 45	1293	ST8200, 8300	515	X1000	492
Radiant 250, 350	1154	ST8400, 8600	611	X1004	201QD
SM10	325	STS6, 55	325	Y2, 3	161
SM20, 30	177	STS100	608	Y11, 100	163
SM100	325	X1, 3, 5	161	Y200	539
SM600	163	X10, 20	492	Y7000, 8000	608
SM710	442	X30	161		

ORTOFON

Original Stylus Number	Original Cartridge Number	Cart-ridge Type	Stylus Tip	Tracking Force	Colour	Diagram	STYLUS		Price Code
							No.	or use:	
D3E D5E	VMS3E/II VMS5E/II	MM MM	E E	0.75-1.5g 0.75-1.5g	White Yellow		1028E 1026E		J J
D10E/II D15 Super D15E Super	VMS10E/II M15 Super M15E Super	MM MM MM	E C E	2.0g 0.75-1.5g 0.75-1.5g	Green Blue Blue		1327E 1023 6710E		J I J
D20E D20S D20E/II D30E/II	VMS20E VMS20S VMS20E/II VMS30E/II	MM MM MM MM	E C E E	0.75-1.5g 0.75-1.5g 1.0g 1.3g	Black Black Black Black		1111E 1111 6700E 6700E		J I J J
D20E Super	M20E Super	MI	E	1.0g	Blue		1102E		J
N5P N10PE	M5P M10PE	MM MM	C E		Black Black		1295 1296E		I J
N10XE NF10E	F10XE FF10XE	MM MM	E E	1.5-2.0g 1.5-2.0g	White White		1028E 1028E		J J
N15, NF15 N15E NF15E	F15, FF15 F15E FF15E	MM MM MM	C E E	1.0-2.0g 1.0-2.0g 1.0-3.0g	White White White		1023 6710E 1023		I J I
N15/II N15E/II	F15/II F15E/II	MM MM	C E	1.5g 1.5g	White White		1027 1028E		I J
NF150/II NF15EO/II	FF15/II FF15E/II	MM MM	C E	2.0g 2.0g	Red Red		1029 1029E		I J
NF15X/II NF15XE/II	FF15X/II FF15XE/II	MM MM	C E	2.0g 2.0g	Yellow Yellow		1025 1026E		I J
Stylus 5 Stylus 5E Stylus 10 Stylus 20 Stylus 30	OM5, OMP5 OM5E, OMP5E OM10E OM20E OM30E	MM MM MM MM MM	C E E E E	1.25g 1.25g 1.25-2.0g 1.25-1.8g 1.25-1.5g	Black Black Black Black Black		1229 1229E 1229E 1229E 1229E		I J J J J
Stylus PRO Stylus DISCO	OM PRO OM Night Club	MM MM	C C		Silver Fluorescent		1229Pro 1229AL		J J
Satellite Satellite	OMP 5 J OMP 5 E	MM MM	C E		White Black Black		1229 1229EJ		J K

PERPETUUM EBNER - PE

Original Stylus Number	Original Cartridge Number	Cart-ridge Type	Stylus Tip	Tracking Force	Colour	Diagram	STYLUS		Price Code
							No.	or use:	
PE5		CE	SR		Metal		202		C
PE12		CE	SR		Metal		203		C
PE182 PE184		CE CE	SR SR		White White		236 234		C C
PE188		CE	SR		White		315		C
PE190		CE	SR		Yellow		457		C
PE192		CE	SR		Grey		418		C
PE223		CE	SR		Grey		419		C
PE194		CE	SR		Black		497		C
PE7000		CE	LP		Red		204		C







PHILIPS

AG3001		CE	LP		Metal		75		C
AG3010,11 AG3013-25 AG5005-09		CE	LP		Metal		29		C
AG3012		CE	LP		Copper		30		C
AG3016, 3019	GP316	CE	LP		Metal		51		C
AG3060, 3063		CE	SR		Copper		52		C
AG3066, 3201		CE	SR		Metal		286		C
AG3301-2	GP380	CE	SR		Metal		71		C
AG3306, 3224 AG3228, 3230 AG3310	GP 200, 204 GP 205, 224 GP230, 306	CE CE CE	SR SR/2 SR/78		White White White		365 87/2 87/78		C C C
AG3311		CE	SR		Metal		408		C
AG3400/10		CE	SR		Metal		86		C
AG3404, 3407	GP404, 410	MM	C		Red		396		I
D204, 205	GP204, 205	CE	SR		White		496		C



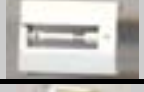

PHILIPS

Original Stylus Number	Original Cartridge Number	Cart-ridge Type	Stylus Tip	Tracking Force	Colour	Diagram	STYLUS		Price Code	
							No.	or use:		
D212	GP212	CE	SR/2		Black		494		C	
D213	GP213	CE	SR/78		Black		494/78		C	
D215D	GP215	CE	SR	5.0g	Black		6470		J	
D330 D331 D350, 351	GP330 GP331 GP350, 351	MM MM MM	C E E	3.0g 3.0g 3.0g	Black Grey Black		1231 1231E 1231E		I J J	
D370	GP370	MM	C	2-4.0g	Beige			497		I
D371	GP371	MM	C	3.0g	Grey			1143	505	I
D397/III	GP397/III	MM	C	1.5g	TrGreen		1174		I	
D400, 500 D401 D401	GP400, 500 GP401 GP401	MM MM MM	C C E	1.5-3.0g 1.5-3.0g 1.5-3.0g	Grey Black Black		495 519 519E		I I J	
D400/II D401/II D412 D422 D412/II D412E/II D422/II D422E/II D500/II	GP400/II GP401/II Super GP412VE GP422 GP412/II GP412E/II GP422/II GP422E/II GP500/II	MM MM MM MM MM MM MM MM MM	C E E E C E C E C	1.5-3.0g 1.5-2.5g 0.75-1.5g 0.75-1.5g 0.75-1.5g 0.75-1.5g 0.75-1.5g 0.75-1.5g 1.5-3.0g	Black Black Black Black Black Black Black Black Black			1030 1031E 519E 519E 1030 1031E 1030 1031E 1030		I J J J I J I J I
D400/III D401/III D412/III	GP400/III GP401/III GP412/III	MM MM MM	C E E	2.0g 2.0g 1.75g	Black Black Black				1223 1223E 1223E	
D499	GP499	VM	C	3.0g	Red				1071	1090
D780	GP780	VM	C	4.0g	Yellow		1155			J
F1650	CZ800.01	CE	C	4.0g	Red		1260		I	
AH975		VM	C	2.5g	Grey		197		I	
AF577		MM	C	1.5-2.5g	TrBlue or Yellow		1067		I	
CZ680	CZ680	CE	C	5.0g	Black		1022	1055	F	
ST17		CE CE	SR/2 SR/78	4.5g 4.5g	White White		475/2 475/78		C C	
CN234, 251		MM	C		Red		1299		I	

PHILIPS

Original Stylus Number	Original Cartridge Number	Cartridge Type	Stylus Tip	Tracking Force	Colour	Diagram	STYLUS		Price Code
							No.	or use:	
MC20		MM	C	2.2g	Red		569		I
EPS270 EPS270ED		MM MM	C C	1.5-2.0g 1.5-2.0g	TrGreen TrGreen		616 616E	158	I J
	YM114	IM	C	1.1g	White		556		I
SX5		IM	C	1.25g	Black		1286		J
N20C		CE	C	4.0g	White		1138		F
N712S		MM	C	1.5g	TrYellow		1100	616	I
STG9		MM	C	2.5g	Red		1208	1243	I
Turntable/System No.	Stylus No	Turntable/System No	Stylus No	Turntable/System No	Stylus No	Turntable/System No	Stylus No	Turntable/System No	Stylus No
3in1 4in1 15AF792 22GP24 23AF620 23AF818 23AM950 AF421 AF429 AF577 AF592 AF729 AF834 AF865 AF911 AH300 AH529 AH530-OO AH557, 577 AH614 AH671 AH685, 777, 857 AH910 AH927 AH955 AH959 AH961, 965 AH971 AH973 AH975 AH978 AH979 AH980, 982 AH999 AH8656 AK501, 530, 540 AS645, 660, 665 CZ680 CZ800.01 DC405, 406, 415 EAK1002, 1005 EAK1009, 1011 EAK1012	1155 1174 6470 87 519 1030 1071 519E 519E 1067 6470 519E ? 87 519E 1260 569 or 1067 1299 569 or 1067 6470 1031E 495 1022 1031E 475 495 475 1022 495 197 197 475 197 475 6470 1299 1260 1022 1260 495 1022 1260 1022 495 1022 1260 1022	EAK1022 EAK1023M, 2006 Electra312 F880, 883 F1275, 1375 F7130, 7230, 7233 F8036 FP142 FP202 FP240, 260 FP440, 455, 563 FP1650 ? FP9300, 9400 FP9410, 9503, 9504 FP9513, 9600, 9650 GA104 GA408 GA437 GC008 GC027/00, 051/00 GC037 GD907 GF907, 908 HI-FI6000 K3101 KS1600, 1800, 1900 KS3100, 3200, 3300 KS3400, 3500, 4200 KS6100, 6200, 6300, 6500 MZ1000, 7347 RF732 RF735, 835 RF855 RH450, 560 RH640 RH805 RH965 RH975 S209 S1210, 1218, 1228, 1310 S1628 S1710 S1728	1260 1155 495 1155 1260 1231 616 or 1071 1231 495 1299 1231 1260 1260 1299 1260 6470 495 1030 1031E 6470 1030 495 495 495 1143 1022 569 569 569 1260 87 494 or 495 6470 495 1030 425E 475 197 569 1022 1155 1175 1155	S1801 S2000 S2200 S2440, 2460, 2600, 2700 S3000 S3013 S4100, 4200 S7000, 7001, 7002, 7003 S7112 S7230 S7505, 7507 S7509 S8036, 8057 S8056 SA9300 SC1003, 1095 SE7WT Sysstem818 T8 TT24 TTXAB5 TTXC1 XA2 XA4 XA5, 8, 55, 500 XA1002, 1011, 1051 XA2003, 2024, 2046 XA3002, 3035, 3051 XA4002, 4200 XA6000, 6600 XB1P XB2, 4, 5, 7, 4081, 4128 XB5129 XB7002, 8004 XC1PB XC2, 3 XC109ST, 1003 XC2115, 3006 XF2F, 2118B XF1185, 2198 ZR1, 2, 1100 ZR1101, 2100	1022 495 569 1022 616 1143 1155 566 495 1231 1143 569 or 1143 616 1022 1260 1260 1260 1030 1286 1208 1260 1155 or 1260 1138 1022 1260 1138 616 1022 1260 1100 1260 1260 1155 1260 1155 1286 1208 1231 1231				







PICKERING

Original Stylus Number	Original Cartridge Number	Cartridge Type	Stylus Tip	Tracking Force	Colour	Diagram	STYLUS		Price Code
							No.	or use:	
R150		CE	SR		Metal		224		C
380D, 3807	U38, 39	MM	C	3.0g	Yellow		99		I
D100 D150 D200 D350 D400 D625 D750 D1200	XV15/100 XV15/150 XV15/200E XV15/350 XV15/400E XV15/625E XV15/750E XV15/1200E	IM IM IM IM IM IM IM IM	C C E C E E E E	3-7.0g 2-4.0g 2-4.0g 1-3.0g 1-2.0g 0.75-1.5g 0.5-1.5g 0.5-1.25g	Black Black Black Black Black Black Black Black		6950 6950 6950E 6950 6950E 6950E 6950E 6950E		I I J I J J J J
DAC2 DAM2 DAME2 DAT2 DATE2	V15AC2 V15AM2 V15AME2 V15AT2 V15ARE2	MM MM MM MM MM	C C E C E	3-7.0g 0.75-3.0g 0.75-1.5g 2-5.0g 2-5.0g	Red Black Black Grey Grey		102 100 100E 100 100E		I I J I J
DAC3 DACE3 DAM3 DAME3 DAT3 DATE3	V15AC3 V15ACE3 V15AM3 V15AME3 V15AT3 V15ATE3	MM MM MM MM MM MM	C E C E C E	3-7.0g 3-7.0g 0.75-1.5g 0.75-1.5g 2-5.0g 2-5.0g	Grey Grey Grey Grey Grey Grey		187 187E 187 187E 187 187E		I J I J I J

PIEZO

AN10, 135	YM10, 135	MM	C	2.0g	Orange or TrSmoke		1160		I
AN101, 102 Y 930	YM101, 102	MM	C	3.0g	White		200		I
AN108	YM108	MM	C	2.5g	Black		161		I
AN113	YM113	MM	C	1-2.0g	Black		6430		I
AN114	YM114	IM	C	1.5-3.0g	White		566		I
AN115	YM115	MM	C	2.2g	Green		508	492	I
AN118	YM118	MM	C	1.5-2.5g	Red		6370		I
AN121 AN122	YM121 YM122	MM MM	C C	1.5-2.5g 1.5-2.5g	Black Orange		7480 1032		I I
AN123, 124	YM123, 124	MM	C	1.5-2.5g	Orange		1086		I
AN125, 127	YM127	MM	C	2.0g	Red or Blue		1159		I
AN218	YM218	MM	C	2.0g	Red		1060		I

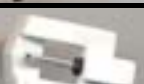

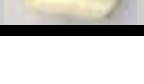



PIEZO

Original Stylus Number	Original Cartridge Number	Cart-ridge Type	Stylus Tip	Tracking Force	Colour	Diagram	STYLUS		Price Code
							No.	or use:	
AN308	YM308	IV	C	1.5-2.5g	Black		6750		I
AN309	YM309	IM	C	1.5-2.5g	Green		6240		I
ANP50C	YMP50C	MM	C	1.25g	Clear		1266		I
ANP 50E	YMP20E,50E	MM	E	1.25g	TrBlue		1266E		J
Y130	Y99, 171, 330	CE	SR	6.0g	Nickel		35		C
Y270		CE	SR	6.0g	Gold		325		C
Y640		CE	C	4.0g	White		163		I
Y670	YM670	CE	C	3.0g	Green		1003		I
Y950	YM103	MM	C	3.0g	White		165		I

PIONEER

PLN3	PLC3	CE	SR	6.0g	Gold		325		C
PLN6, 7	PLC6, 7	MM	C	3-4.0g	White		165		I
PLN9	PLC9	MM	C	2-3.0g	White		7380		I
PN10	PC10	MM	C	2.5-3.5g	White		190		I
PN11	PC11	MM	C	2.5-3.5g	Grey		190		I
PN12, 110	PC12, 110	MM	C	2.5-3.0g	Red or Blue		528		I
PN14	PC14	MM	C	2.5-3.5g	Green		190		I
PN15, 20	PC15, 20	MM	C	1.7-2.3g	Red or Blue		190		I
PN16	PC16	MM	C	1.2-2.0g	Grey		7420		I
PN21	PC21	MM	QD	1.7-2.3g	Ivory		554QD		L
PN30	PC30	IM	C	1.5-3.0g	Rose		529		I
PN33MC		VM	C	1.8g	Black		1200MC		L
PN 35	PC35	IM	C	2.0-3.0g	Yellow		193		I
PN50	PC50	MM	C	1.5-3.0g	Violet		529		I

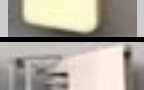
PIONEER

Original Stylus Number	Original Cartridge Number	Cart-ridge Type	Stylus Tip	Tracking Force	Colour	Diagram	STYLUS		Price Code
							No.	or use:	
PN110/II	PC110/II	MM	C	1.5-2.5g	Black		7390	528	I
PN131	PC131	VM	C	1.5-2.3g	Yellow		1051		I
PN135	PC135	MM	C	2-3.0g	Black		593		I
PN150	PC150	MM	C	1.7-2.5g	Yellow		528		I
PN200	PC200	MM	C	1.7-2.3g	Green		1037		I
PN220	PC220	VM	C	2.0g	Cream		1128		J
PN230	PC230	VM	C	2.0g	Green		1155		J
PN250T,259T PN295T	PC250	VM	C	1.3g	White or Black		1177		J
PN290T,300T	PC290, 300	IM	C	1.25g	White		1245		I
PN291, 301	PC291, 301	IM	C	1.0g	Grey		1268		I
PN305T		VM	E	1.3g	Green or Black		1177E		K
PN330 PN550E PN1000E	PC330 PC550E PC1000E	MM MM MM	C E E	1.4-2.0g 0.7-1.5g 0.7-1.7g	Dk Green Rose Black		1108 1108E 1108E		I J J
PN330/II PN550E/II PN1000/II	PC330/II PC550E/II PC1000/II	MM MM MM	C E E	1.0-1.8g 1.0-1.8g 0.7-1.7g	TrSmoke TrSmoke TrSmoke		7410 1104E 1104E		I J J
PN400 PN600 PN800	PC400 PC600 PC800	MM MM MM	C C C	1.0-1.8g 1.2-1.8g 0.8-1.8g	Green, White or Yellow		1037		J
PN770EX	PC770EX	MM	QD	0.7-1.8g	White or Black		554QD		L
PNK65		MM	C	1.5g	White		1178		I
PNK85	PXT968	IM	C	2.5g	Lt Grey		574		I
PNQ1	PC50	MM	QD	1.5-2.5g	Violet		1105QD		L
RK8		IM	C	3.0g	Blue		558		I





PIONEER

Turntable/System No	Stylus No	Turntable/System No	Stylus No	Turntable/System No	Stylus No
Avanti 1	593 or 7390	PL77A	1268	PLA30, 31	190 or 528
Avanti 2, 11, 33	7390	PL88	deleted	PLA35, 45D	531
Avanti 55, 77	528	PL100	7390	PLA50	576
Avanti 66	1178	PL110	528 or 1178	PLA61	190 or 528
Avanti 110, 220, 330, 440	1128	PL117D	593	PLC7	1071
Avanti 500	7390	PL120	1128	PLJ2500	1155
Avanti 550	deleted	PL122	1104	PLL50	1245
Avanti 700, 900	528	PL155E	7390	PLL70	1268
Avanti 770, 990	deleted	PL200	7390 or 1177	PLL100A, 800	deleted
Avanti 3000, 3100	1177	PL210	1155	PLL1000	1037
Avanti 4000, 4100	1177	PL221Z	1245	PLS30	1155
Avanti 5000, 5100	1177	PL222Z, 223, 230	1155	PLS40, 50, 70	deleted
Avanti 6000, 7000	1177	PL255	528	PLT3	1128
Avanti 7200	1155	PL260, 280	deleted	PLX5	1128
Avanti 8000	1177	PL295	1177	PLX7, 9	deleted
Centre 320	558	PL300	528	PLX21Z	1235
Centre 520, 5522	593 or 7390	PL310	1155	PLX33	1177
Centrex	528	PL312	528	PLX44	1177
CP2000AM	1245	PL320, 330	1128	PLX50	1071
E1000AH	190	PL333Z	1155 or 1177	PLX55	1177
ES1000, 2000, 4000L	190	PL335, 340	1155	PLX77	1177
FD3	531	PL360, 370, 380	1037	PLX88	1177
FG3	554QD	PL400	528	PLX99	1177
Form 4000, 4400	7390	PL420	deleted	PLX111	1245
Form 5500, 6000, 6600	7390	PL430	1128	PLX200	1245
KH450, 550, 750, 3355	574	PL450	1177	PLX220	1177
KH4455, 5222	574	PL466	1155	PLX221Z	1245
KH5522	593 or 574	PL470	1177	PLX300	1177
KH5577, 8811, 8855	574	PL480	1177 or 1245	PLX333Z	1177
KH8875	574	PL500	1037	PLX400	1268
KN5511	528	PL505	deleted	PLX500	1071
MS350, 450, 550, 750	574	PL510A	593 or 531	PLX505	1177
MS850	574	PL512, 514	7390	PLX555Z	1177
MS5522, 6200, 6500	593	PL516, 518	593 or 7390	PLX700	1245
MSZ7	1155	PL530, 540	531 or 1155	PLX707	1177 or 1268
MX8Q	528	PL550	531 or 1155	PLX777	1177
MX40	1178	PL555Z	1155 or 1177	PLX888Z	1177
MX650	593	PL560	1037,1177,1245	PLY7, 9	deleted
PA1, 3, 5	1155	PL570	1037 or 1177	PLZ71	1155
PDZ71	1155	PL590		PLZ81, 82, 85	1155
PE66A	1155	PL600	1037	PLZ91, 92, 94	1155
Persona X220, X550, X880	1177	PL620	deleted	PLZ212	1245
PL05	deleted	PL630	1037	Prelude 500	190
PL2, 3, 4, 6, 7, 8	1128	PL640, 666	deleted	Prelude 600	528
PL9	deleted	PL670	1177	Prelude 700	528
PL12R	190 or 528	PL707, 720, 730	deleted	Prelude 1000, 2000	190
PL15	190	PL740, 750, 780, 800	deleted	Prelude 4000	190
PL15D	531	PL860, 880	1177	PZP1004	1155
PL15R	528	PL930, 950	deleted	Rondo 1000, 2000	190
PL25D, 25E	190 or 528	PL990	1155 or 1308	Rondo 3000	190 or 593
PL30	531E	PL1120, 1150, 1160	593	Rondo 4000	190
PL31, 41D	576	PL2200	1155	Rondo 5000	7390
PL44	deleted	PL3000	528	S 1, 2, 3	1155
PL50	576	PL4200	1071	SL720, 730	deleted
PL51	531 or 1037	PL5100	1071	SL930	deleted
PL55	deleted	PL5522	593	SPL110	1178
PL61, 71	531 or 1037	PL6100, 7100	deleted	SPL120	190,593,1178
PL66F	deleted	PLA25	576	STL100	528

POWER POINT

Original Stylus Number	Original Cartridge Number	Cart-ridge Type	Stylus Tip	Tracking Force	Colour	Diagramm	STYLUS		Price Code
							No.	or use:	
51	51	CE	LP/2		Red		55		I
56	56	CE	LP/78		Blue		56		I











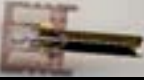

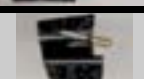

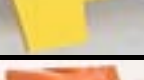

PYE

Turntable or System Number	Cart-ridge Type	Stylus Tip	Tracking Force	Colour	Diagram	STYLUS		Price Code
						No.	or use:	
25J3, 4, 5, 6; MA486, 487 MA541, 542, 560, 562; MB29 MC29, MF29, MG29 MR527, 529, 551, 553, 554, 558 MR594, 651, 652 SD19, 29; SE19, 29 SR422, 423, 431, 513 TS1/IV, TS19, 26, 27, 29, 30	CE CE	SR/2 SR/78	7.0g 7.0g	White White		404/2 403/78		C C
811, 911S; MB18 TS1/V, 1-VII, 1-XI, 1-XII, 1-16 TS1-18, 1-188 TS22, 23, 24, 25	CE CE	SR/2 SR/78	3.5g 3.5g	White White		88/2 88/78	442/2 442/78	C C
C2680, 2689; DL12, 16 EAK1005, 1012, 1013, 1014 EAK1015; FV110HR. MC1, 2, 3, 4, 5, 6, 7, 8, 561, 581 MC582, 600, 2137, 2317, 5128 MC5328, 5335, 5400, 5627, 5913 MC7129, 7139, 7339, 7529, 7700 MC8334, 8700.; MRC3, 5, 7, 8 MS1B, 2, 3, 4, 5E, 6, 7, 8, 160 MS1342, 2118, 2137, 2334, 2336 MS2337, 2700, 3400, 3636, 3641 MS4000, 4200, 4344, 5340, 6200 MS6337, 6340, 7200, 7337, 7340 MS8334, 8337, 8700; MZ3ER MZ8D, 334, 1000, 2959, 3347 MZ3400, 3847, 8548; QD40 SH1, 2, 1337, 1342, 2337, 2964 SN1, 1200, 1337, 1342; SR6E SR6200, 6337, 6342; TA8, 18	CE	C	6.0g	Black		1022	1055	F
C800.01; EAK1005A, 1010 EAK1011, 1022, 1023.; KM2, 2000, 3000, 4000 LX1000, 1250, 1400, 1500, 1750 MD1, 2, 3, 2650, 2700, 3700, 4700 MG1A, 3, 5, 6, 1400, 2000, 3200 MG4300, 4400, 4976, 5400, 6972 MS4200, 4344; MZ4E, 8P, 1000 MZ4200; TTXC, XB1P.	CE	C	4.0g	Red		1260		I
Diotran, TA5, 6	VM	C	2.5g	Yellow		608		I
EAK1004, 1017; M22; MG9ED, MG9268; MZ9E, 9553E	MM	C	2.5g	Red		1208	1243	I
EAK1017	MM	C	2.0g	Red		1060		I
FL2500 Isotronic PU330	VM	C	3.0g	Grey		197		I
HF1, 15, 1155 P8	IM	C	1.25g	Black		1286		J
JH302; MC8125, 8133, 8331, MC8533, 8700; MD7; P4, 4505 P4507, 4509; PL4, 12; TT1M	VM	C	2.5g	Yellow		1155	1167	J
M28E	VM	C	1.3g	White		1177		J

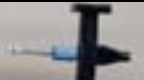
PYE

Turntable or System Number	Cart-ridge Type	Stylus Tip	Tracking Force	Colour	Diagram	STYLUS		Price Code
						No.	or use:	
MA492, 494, 505, 506, 571 MR461, 472, 473, 502, 503, 505 MR506, 507, 661, 662 SR431, 513 TS18C	CE CE	SR/2 SR/78	5.0g 5.0g	White White		442/2 442/78	88/2 88/78	C C
MA561	CE	SR		Black or Grey		496		C
MA671, 672, 711, 712 MR484, 594, 651, 652, 661, 662 MR669 MS4000, 4200, 4344	CE CE	SR/2 SR/78		Black Black		444/2 444/78		C C
MC3, 4, 5, 7, 8, 510, 512, 532 MC560, 562, 580, 5124, 5127 MC5524, 5527, 7130, 7137 MC7330, 7337, 7530, 7537 MC8125, 8133 TA12, 17	CE	C	3.0g	Blue		594	164	I
MC100, MR100, 462, 463, 464, 741 TA1, 2, 3, 4	MM	C	1.5-3.0g	Beige		414	498	I
MC6400, 6602 MS1, 3, 4, 5E, 1400, 1636, 5200 MS5337, 5340,	CE	C	4.0g	White		1138		F
MC8100 P900, 4504, 4505	MM MM	C E	1.5-2.0g 1.5-2.0g	TrGreen TrGreen		616 616E	158	I J
MRC1, 2, 4, 25A TA9	CE CE	SR/2 SR/78	4.5g 4.5g	White White		475/2 475/78	499	C C
MRC4, 6, 8; TR8	CE	SR		Metal		325		C
MRC9; MS9, 3041, 9343, 9543, 9545 TA15	CE	SR		White		1132		C
MRC801	CE	SR/2		Black		520		C
MRC801 T508	CE	SR		White		1109		C
MS1 TA14, 16	MM	C	2.2g	Red		569		I
P4, 500 SA600A, SK58C TA11	MM	C	1.5-2.5g	TrYellow		1067		I
ST119, 1114, 1119	CE	C		Red		1307		I
T5, 6	MM	C	4.0g	Red		492		I
TA7	MM	C	3.0g	TrRed		505	1143	I
TA9	IM	C	1.5g	Black		1084		I



PYE

Turntable or System Number	Cart-ridge Type	Stylus Tip	Tracking Force	Colour	Diagram	STYLUS		Price Code
						No.	or use:	
TA10	MM	C	3.0g	TrSmoke		184		I
TA11	MM	C	2.5g	Blue		579		I
TA20	MM	C	1.8g	Black		1081		I
TS1/II	CE CE	SR/2 SR/78		Black Black		445/2 445/78	446/2	C C
RANK ARENA								
MC200	CE	SR		Metal		325		C
MC301 PL500 RA5300, 6200, 6300	MM	C	2.0-2.5g	LtGreen		539		I
MS650, 651 RA301, 303	CE CE	SR/2 SR/78		White White		475/2 475/78	499	C C
Music Tower, PL100 RA20, 30, 80P	VM VM	C E	2.5g 2.0g	Yellow Green		608 608E		I J
P660	MM	C	2.0-2.5g	Orange		7450		I
RA5C, 50, 100MC, 304	CE	C	6.0g	Black		1022	1055	F
RA10T, 30MX	MM	C	2.0g	Red		1060		I
RA75MC, 100MC, 302, 304	CE	C	3.0g	Blue		594	164	I
RA305	MM	C	2.0-4.0g	Beige		497		I
RA306	MM	C	3.0g	White		6270		I
RA306, 401, 402, 407, 5000P	MM	C	3.0g	Tr Red		505	1143	I
RA1000P	MM	C	1.5-2.5g	Black		7480	7730	I



REALISTIC — TANDY

Turntable or System Number	Cart-ridge Type	Stylus Tip	Tracking Force	Colour	Diagram	STYLUS		Price Code
						No.	or use:	
BD1000; RSKC8 LAB30, 36, 38, 50, 53, 54, 100 LAB248, 1600, 1700	IM	C	3.0g	Blue		558		I
BDA1500 LAB12C	MM MM	C E	1.8-3.5g 1.3g	Blue Red		170 173E	171	I J
Clarinette 49, 98, 105 LAB 48	CE CE	SR/2 SR/78	4.5g 4.5g	White White		475/2 475/78		C C
Clarinette 116	CE	SR	3.2g	White		1109		C
Clarinette 121, 122, 123 M3500; System 100	CE	C	4.0g	Red		1260		I
Clarinette 600	MM	C	2.5g	Blue		579		I
LAB110	MM	C	2.5g	Red		1184		I
LAB260 R8X, 25ED, 27ED, 47ED; RS6E STA 790	MM	E	0.75-1.5g	Black or Yellow		456E		J
LAB290, 303, 390, 440 R1000, 8010; RS8T	MM MM	C C	1.5-3.0g 3.0-5.0g	Beige Blue		414 498		I I
LAB300, 400, 440	MM MM	C E	0.75-1.5g 0.75-1.5g	Red Yellow		186 186ED		I J
LAB 303 TV7022	MM MM MM	E C 78rpm	2.5g 2.5g 2.5g	Blue Red Red		1190E 1190 1190-3		J I J
LAB 330, 350, 1500, 2000, 2080 LAB2100, 2200, 2290 RT1500; ST500, STA2280	MM MM	C E	1.3g 1.3g	Grey Green		1191 1191E		J K
LAB500 R9000 RS9E	MM	E	0.75-1.5g	Yellow		606ED		J
LAB701, 801 RX8500	VM VM	E C	1.3g 1.3g	Green White		1177E 1177		K J
LAB730; ST204	MM	C	1.5g	TrGreen		1172		I
LAB302, 1100	VM VM	C E	2.5g 2.0g	Yellow Green		1155 1155E	1167	J K
LAB 770 RS5T, R5X	MM MM MM	C 78rpm E	1.5-3.0g 1.5-3.0g 1.5-3.0g	Beige DkGreen LtGreen		6890 6890-3 6890EJ		I J J
LAB1000	IM	C	3.0g	Red		1179		I
LAB1750	MM	C	2.5g	Red		1208	1243	I

REALISTIC — TANDY

Turntable or System Number	Cartridge Type	Stylus Tip	Tracking Force	Colour	Diagram	STYLUS		Price Code
						No.	or use:	
RXP3	MM	E	1.25	Red		1237E		J
RXT4, 5	MM	E	0.75-1.5g	Black		1275HE		L

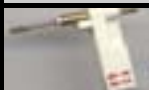
RCA

Original Stylus Number	Original Cartridge Number	Cartridge Type	Stylus Tip	Tracking Force	Colour	Diagram	STYLUS		Price Code
							No.	or use:	
110.023		CE	SR/2		Gold		313		C
110.220		CE	SR/2		Black		366		C

REUTER

SD1, 2, 3		CE	SR		Metal		76		C
-----------	--	----	----	--	-------	--------------------------------------------------------------------------------------	----	--	---

RONETTE





BF40	DC284	CE	SR	6.0g	Nickel		44		C
CMT102		CE	SR		Metal		472		C
DM500	SM500	MM	C	1.8g	Blue		170	171	I
O, P, T	MT67	CE	LP	6.0g	Metal		17		C
SC107, 109		CE	SR	5.0g	Black		461		C
TA600		CE	SR/2		Black		416		C
TO284	TO284	CE	SR	6.0g	Metal		325		C

ROTEL

Original Stylus Number	Original Cartridge Number	Cartridge Type	Stylus Tip	Tracking Force	Colour	Diagram	STYLUS		Price Code
							No.	or use:	
RN1-01	2RC1	MM	C	2.0g	Red		1097		I
RN2, 4	2RC2, 4	MM	C	2.0g	Red		539		I
RN3	2RC3	MM	C	3.0g	TrBrown		184		I
RN5	2RC5	VM	C	2.0g	Yellow		608		I
S400		MM	C		Red		1060		I
20SC		MM	C		Red		1184		I
165-5		VM	C	2.0g	Yellow		1070		I
RP500		MM	C	1.5g	Black		1036		I
RP1000		MM	E	0.75-2.0g	Yellow		425E		I

Turntable/System No	Stylus No	Turntable/System No	Stylus No	Turntable/System No	Stylus No
CN2424 RMC7 RP300 RP310 RP400 RP500	608 1200MC 539 608 1060 1036 or 1070	RP700 RP830, 840 RP850 RP860 RP1000 RP1001	608 1097 DELETED 1097 425E or 184 608	RP1100 RP1500 RP2300, 2500, 3000 RP3100, 3300, 5300 RP9400	184 or 608 184 184 or 608 608 608

SAMSUNG

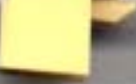
SMC8100	MM	C		Black or Grey		1308		J
SML8550 VIP300, 330	CE	C	4.5g	Red		1260		I
SMC8000	MM	C	2.5g	Red		1208	1243	I
VPI500, 6700	CE	C		Red		1307		I
VIP590, 690	IM	C		Violet		1306		G
VIP680	VM VM	C E	2.5g 2.0g	Yellow Green		1155 1155E		J K

SANSUI

Original Stylus Number	Original Cartridge Number	Cart-ridge Type	Stylus Tip	Tracking Force	Colour	Diagram	STYLUS		Price Code
							No.	or use:	
SN10	SV10	MM	C	2.0-2.5g	TrBlack		527		I
SN10D, 23	APS310	MM	C	3.0g	White		200		I
SN21, 22 ST6D	AT6	MM	C	3.0g	White		165		I
SN24 ST9D	AT21	MM	C	2-3.0g	White		180		I
SN25	MC1-5	MM	C	2.5-3.5g	Grey		512		I
SN26	MC6S	MM	C	2.0g	Yellow		184		I
SN27	SV27	MM	C	1.5g	Black		572		I
SN28	SV28	MM	C	2.5g	Beige		564		I
SN29	SV29	MM	C	1.5-2.0g	Red		7440		I
SN31, 32 ST3100, 3200	SC31, 32	MM	C	1.5-2.0g	White		159		I
SN33	SV33	MM	C	2.5g	Grey		508	492	I
SN34	SV34	MM	C	3.0g	LtGreen		545		I
SN37	SC37	IM	C	2.5g	Grey		574		I
SN38	SV38	IM	C	3.0g	Red		565		I
SN40X SN43		VM VM VM	QD E C	2.0g 2.0g 2.0g	White Red Beige		525QD 197E 197		L J I
SN41	SV41	MM	C	2-2.5g	Orange		7450		I
SN42	SV42	MM	C	1.5-2.0g	TrWhite		7470		I
SN44 SN47	SV44 SV47	MM MM	C C	2.0-2.5g 2.0-2.5g	Black Orange		7480 7730		I I
SN45	SV45	MM	C	1.5-2.0g	Black		7490		I



SANSUI

Original Stylus Number	Original Cartridge Number	Cart-ridge Type	Stylus Tip	Tracking Force	Colour	Diagram	STYLUS		Price Code		
							No.	or use:			
SN50	SV50	IM	C	2.0g	White or Red		508	492	I		
SN60 SN80	SC60 SC80	MM IM	C C	3.0g 3.0g	Orange Red		1224 1179		I I		
SN101		VM VM	C E	2.0g 2.0g	Yellow Green		608 608E		I J		
SN111		VM VM	C E	2.0g 2.0g	Red Green		1155 1155E		J K		
SN202		VM VM	C E	2.0g 2.0g	Yellow Green		1071 1071E	1090	I J		
SN303		VM	C	1.7g	Black		1187		J		
SN333		MM	C	1.2g	TrWhite		1266		I		
SN505		VM	C	2.0g	DkGrey		1232		I		
SN707		VM	C	2.0g	Blue		1227		J		
SN757, 909		VM	C	2.0g	Black or Red		1254		J		
SNP212		IM	C		Red		1288		I		
SNP313, 515		VM VM	C C	1.3g 1.3g	White Green		1177 1177E		J K		
ST1		CE	SR	6.0g	Metal		325		C		
		MM	C	2.5g	Red		1208	1243	I		
Turntable/System No		Stylus No		Turntable/System No		Stylus No		Turntable/System No		Stylus No	
APS1200, 1400 CRM330 DAP500,555 DAP550 DAT500 FR212 FR232 FR1080, 4060 FR5080S FRD3, 4, 35, 55, 259 FRD25 FRD40 FRQ5 Mys1 P50 P1000		159 1177 1179 1224 or 1288 1179 564 508 574 197 492 574 1071 508 1288 574 1155		P2000 PD10, 20, 30 PD11, 15, 21, 31, 41 PD51 PL15, 33, 35,41,45,51,55 PL40, 50 PL75 PL95R PM7 PM50, 55, 330, 500 PM70, 77 PM90 PM700 PM900 PR500 QRX5		1258 574 or 1179 1177 1227 1177 1232 1227 1177 or 1254 1187 1177 1177 1254 1227 or 1254 1177 or 1254 1208 1187		QRX9 R410 SR212, 222, SRB299 SR232, 333, 535, 838 SR313, 4050, 4060 SR323, 525, SRB200 SR636, 737 SR1050,2020,2030 SR1080 SR2050, 3030 SV40X XPQ9		608 1177 574 508 545 564 197 159 545 or 574 159 197 608	

SANYO

Original Stylus Number	Original Cartridge Number	Cart-ridge Type	Stylus Tip	Tracking Force	Colour	Diagram	STYLUS		Price Code
							No.	or use:	
ST03	DCWO3	CE	C	4.0g	White or Red		1153		I
ST05D	MG05	CE	C	4.0g	Red		1260		I
ST07D ST08D	MG07 MG08	MM IM	C C	2.5-3.5g 2.5-3.5g	Red Black		1263 1274		I I
ST09D		MM	C		Red		1299		I
ST3 ST4	CZ200	CE CE	SR/2 SR/78	5.0g 5.0g	White White		88/2 88/78		C C
ST5D	MG2	MM	C	3.0g	White		512		I
ST6D	MGT1, 42A	CE	C	3.0g	White		163		I
ST8D	MGT2, 42K	CE	C	3-4.0g	White		195		I
ST9D		CE	SR		Black		166		C
ST10D	MGT3	CE	C	3.0g	Nickel		176		F
ST10J	MG10J	MM	C	2.0g	Black or Orange		1019		I
ST11D		CE	C	5.0g	Black		463		F
ST12D	MG03	MM	C	3.0g	White		165		I
ST14D	M6T5	CE	C	3.0g	Ivory		164	594	I
ST15GD ST15LD	MG15G MG15L	MM MM	C C	3.0g 3.0g	Smoke Orange		184 184		I I
ST15J		CE	C		White		1204		I
ST17D	MG17	CE	C	5.0g	Red		7650		I
ST20D	MG20	MM	C	1.5-2.0g	Black		579		I
ST20J		MM	C	2.0g	Black		1166		I

SANYO

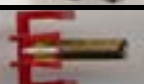
Original Stylus Number	Original Cartridge Number	Cart-ridge Type	Stylus Tip	Tracking Force	Colour	Diagram	STYLUS		Price Code
							No.	or use:	
ST25	MG25	MM MM	C E	2.5g 1.3g	Blue Red		170 173E		I J
ST25J		MM	C	3.0g	White		508	492	I
ST26D	MG26	MM	C	2.5g	Orange		524		I
ST26J		VM VM	C E	4.0g 2.0g	Grey Green		608 608E		I J
ST27D	MG27	MM	C	2.5g	Blue or Black		579		I
ST28	MG28	IM	C	2-4.0g	Red		565		I
ST29D	MG29D	MM MM MM	C E 78 rpm	2.5g 2.5g 2.5g	Red Blue Red		1190 1190E 1190-3		I J J
ST30	MG30	MM	C	3.0g	Red		6270		I
ST30J		VM	E	1.7g	Black or Caramel		1196E		J
ST34D		MM	C	2.5g	Red		1060		I
ST35D, 41J		VM	C	2.0g	Grey		1090	1071	I
ST35VD ST36VD		VM VM	C C	2.5g 4.0g	Grey Red		197 197E		I J
ST37D		MM	C	1.5g	Blue		1185		I
ST38D		MM	C	2.0g	Black		1186		I
ST40DX	MG40X	MM	QD	2.5g	TrBrown		201QD		L
ST41D	MG41	MM	C	2.0g	Blue or Black		1096		I
ST42D		VM VM	C E	2.0g 2.0g	Red or Yellow Green		1071 1071E	1090	I J
ST43		MM	C	1.5g	Black or Orange		1015		I
ST44D	MG44	MM	C	2.0g	Black		1137		I

SANYO

Original Stylus Number	Original Cartridge Number	Cart-ridge Type	Stylus Tip	Tracking Force	Colour	Diagram	STYLUS		Price Code
							No.	or use:	
ST44J		VM	C E	1.3g 1.3g	White Green		1177 1177E		J K
ST45DX	MG45X	MM MM	QD C	2.0g 2.0g	Black or Blue Orange or Blue		555QD 524		L I
ST47D		IM	C	1.5g	Black		1178		I
ST48D, 107	MG48	MM	C	3.0g	LtGreen		1143	505	I
ST50D	MG50	MM	C	1.8-2.5g	Black		7450		I
ST51D, J		VM	C	1.5g	Red		1175		I
ST53D		VM	C E	1.5g 2.0g	Yellow Green		1070 1070E		I J
ST55D ST57D		MM MM	C E	2.5g 2.5g	Red Blue		1190 1190E		I J
ST63D		VM	C E		Yellow Green		608 608E		I J
ST66D	MG66	MM	C	1.25g	Red		1241		I
ST67D		IM	C	1.25g	Black		1278		I
ST100SD	MG100S	VM	C	2.0g	Black		1110		J
ST101SD		VM	C	1.5g	Black		1180		J
ST102SD	TPWO11	VM	C	1.5g	Black		1297		I
ST103SD		VM	C	2.5g	Black		1168		J
ST140D ST707J		CE	C	6-7.0g	Red		1279		I
STA1SD		VM	E	1.3g	Yellow		6820E		J
STA3D		VM	E	1.5g	Brown		584E		J
STF8D		VM	C	1.3g	White or Black		1177		J





SANYO

Original Stylus Number	Original Cartridge Number	Cartridge Type	Stylus Tip	Tracking Force	Colour	Diagram	STYLUS		Price Code
							No.	or use:	
STG1	MGT6	CE	C	6.0g	Black		194		F
STG2	G2611	MM	C	3.0g	Beige		1143	505	I
STG3		CE	C	6.0g	Metal		325		C
STG5		CE	C	6.0g	Black		1022		F
STG6	RS07260	Ce	C	5.0g	Black		1055		F
STG7		MM MM	C E		Blue Red		579 603E		I J
STG8	G2002, 3002	MM	C	2.0g	Red		1060		I
STG9 STG10 STG11		MM MM IM	C C C	2.5g 3.0g	Red Blue Violet		1208 1243 1306		I I I
STG12		MM	C	2-3.0g	Red or Blue		1258		I
STG13		CE	C	6-7.0g	Red or Grey		1279		I
STG14		MM	C	2.0-2.5g	Red		1288		I
STG15		MM	C	3.0g	TrBrown		184		I
STL5D STW8J		VM	C	3.5g	Yellow		1155		J
STM11		VM	C	1.3g	DkGrey		1177		J
ST59U STW17J ST868J		MM	C		Red		1299		I
STWW3		CE	C	6-7.0g	Red		1260		I
N75-6/II		MM	C		Beige		414	498	I
N20C		CE	C		White		1138		F
ST16D ST17D		CE CE	SR/78 SR/2	4.5g 4.5g	White White		475/78 475/2	499	C C
MC7		MM	C		Black		196		I

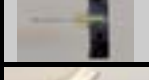
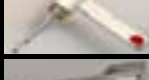

SANYO

Turntable/System No	Stylus No	Turntable/System No	Stylus No	Turntable/System No	Stylus No
7WS	1015	G3002	1060	TP33	1299
D2620NK	194	G3230	1155	TP78	512
DC3711	325	G4560	163	TP80	184
DC40	35	G5230	1155	TP88	1177
DC45K	1022	GXT100, 160, 170	1022	TP91	170
DC53K	603E	GXT110, 150	1194	TP105	88
DC81, 85X	184	GXT180	1260 or 1279	TP115	325
DC91, 93	176	GXT200	1022 or 1243	TP220	1155
DC300K	184	GXT210, 230, 255	1208	TP222, 240, 266, 268	1177
DC310, 320, 330T	88	GXT211	1022 or 1279	TP250	524
DC331K	512	GXT215	1260	TP366, 430	1177
DC420X	184	GXT300, 320, 350, 360	1022	TP405, 525, 535	565
DC434, 500	512	GXT310, 330, 410, 445	1208	TP500	184
DC520	176	GXT430	163 or 194	TP505	1110
DC530	565	GXT520, 550	1022	TP560	1288
DC534, 535	512	GXT707, 747, 757	1260	TP567	1177
DC550	184	GXT727	1279	TP600	170 or 197
DC570X, 602N, 831	195	GXT818, 828, 909, 949	1260	TP525, 626	565 or 7650
DC570XL	325	GXT2005		TP628	176
DC580, 600, 620XKC	88 or 176	GXT4301	325	TP635U	1015
DC602	196	GXT4315	163 or 194	TP636	565 or 197
DC610	176	GXT4360, 4410	325	TP700, 705, 800	170
DC620XK, 710, 711, 750	164 or 195	GXT4404, 4414	1022	TP725, 727	565
DC630, 640, XKC, 650	88	GXT4451	163	TP728	197
DC636	512	GXT4500	88 or 1143	TP740	1096
DC640XK	164	GXT4501, 4503	325 or 184	TP825	197 or 1071
DC800, 880, 904	325	GXT4504	1022	TP880	1110
DC900	88 or 325	GXT4504K, 4505, 4507	325 or 184	TP929	565 or 7450
DC931N	163	GXT4512, 4514	325	TP929A	197
DC4504	1022	GXT4515	163 or 194	TP999	1241
DC4800K	579	GXT4521	325	TP1000	170, 524, 1015
DC5006K	1022	GXT4530, 4535, 4536	1022	TP1001, 1005	565, 1015, 1071
DC6000	184	GXT4540	325	TP1010, 1012	565 or 1015
DC6100, 7100K	170	GXT4545	1143	TP1014, 1024	1090
DC6710	164	GXT4548	1060	TP1020	579 or 1208
DC8500K	524	GXT4551	163	TP1030	1015
DCJ3, 5, 6	565	GXT4560	325 or 163	TP1100, 1200	524 or 197
DCJ3K, 6K	579	GXT4565	163 or 194	TP1400	1155
DCM300	194 or 1022	GXT4580	1143	TP1800, 3250, 8250	197
DCM517K	579	GXT4590	325	TP2200	1155
DCM4404K	1022	GXT4615	1022	TPAV1	1175
DCW03, 09	1153	GXT4640	166	TPC20	1155
DCW07	1185	GXT5442, 5450	88	TPD5	1186
DCW17K, 517K	579	GXT5502	565	TPD10	1096
DCW801	6270	GXT5600	184	TPF5, 6	1153
DCWM20, 40, 100	1022	GXT7000	565	TPF8	1177
DCWM150, 300	1022	H460	88	TPF88	1096
DCXW8, 17, 18	1155	JXT40, 44, 45	1055 or 1261	TPM1	1185
DCXW17, 27	1299	JXT55	1022	TPM5	1153 or 1186
DS18, 20, 21, 22, 23, 25	325	JXT4044	1055 or 1138	TPM10	1070
DS33, 40, 41, 50T, 92	325	JXT4404	1022	TPM11	1177
DS93, 95, 404	325 or 176	JXT4406	475	TPM15	1110 or 1180
DXT540, 550, 600	184	JXT4800	1143 or 7480	TPM50	1153
DXT4530, 5006, 5007	1022	JXT6420	1022	TPM500	1186
DXT5404, 5828	197	JXT6430	170, 565, 1022	TPM600	1185
DXT5406, 5600, 5806	524 or 7650	JXT6440	475, 608, 1022	TPQ7	1153
DXT5502	565	JXT6444	1022	TPQ50	1090
F3	176 or 1015	JXT8500	1015	TPW10	1153
F5	565	MT30, 32, 35	1190	TPW30	1258
F5WF	414	MT911	1299	TPW400	1177
F6, 7	1015	MT6360	1022	TPWO7LT	1185
G1005, 1517, 1523	1055	PG12	325	TPWO11	1297
G1400	1155	Q25, 40, 60	1015	TPWW4	1153
G2002	1060	RP118X	1278	TPX1	1071 or 1204
G2212, 2213, 2215	325 or 194	RS07260	1055	TPX2, 3	1071
G2216, 2312	325	S210	565	TPX600	1260
G2416	88 or 163	SPT1007, 1100	325	TPX801, 900, 1000	1299
G2512, 2517, 2519, 2602	325	System 220, 330	1155	W8, 17, 18, 27	1155
G2515/II, 2601	88 or 163	System 266	1137	XRQ5, 7, 9	608
G2611	1143	System 346	1177		
G2612, 2615	325	System 1020	1060		
G2690NK	194	T18, 20, 21, 25, 40, 41	325		



SCHUMANN MERULA

Original Stylus Number	Original Cartridge Number	Cart-ridge Type	Stylus Tip	Tracking Force	Colour	Diagram	STYLUS		Price Code
							No.	or use:	
SK451		CE	LP		Metal		37		C
SK456		CE	LP		Metal		270		C
STC485		CE	SR		Black		452		C
STK481		CE	SR		White		346		C
STK490		CE	SR		Metal		57		C
STK495		CE	SR		Metal		345		C







SCOTT

20SC	PS48, 49	MM	C	2.5g	Red		1184		I
21SC		VM	C	2.5g	Red		1070		I

SEEBURG

Juke Box	V200	CE	C		Blue		1255		J
Show Case		MM	C		Yellow		1156		I

SHARP

N05D N06S	C91D	MM	C	3.0g	White		165		I
N11D		CE	C	4.5g	Black		178		F
N13D	C512D	CE	C	4.5g	Black		177		F
N14S	C450	CE	C	4.0-4.5g	Black		179		F
N15D	C21D	MM	C	3.0g	Black		160		I
N17D	C93D	IM	C	2.0-2.5g	Grey or LtGreen		180		I
N20D	C95D	VM	C	4.0g	Grey		197		I

SHARP

Original Stylus Number	Original Cartridge Number	Cart-ridge Type	Stylus Tip	Tracking Force	Colour	Diagram	STYLUS		Price Code
							No.	or use:	
STY001		CE	C	5.0g	Black		1055		F
STY20SG		MM	C	2-3.0g	Red		1184		I
STY100	Cart100	MM	C	3.0g	Red, Green or Blue		545		I
STY101, 110 STY111	Cart101	MM	C	2-2.5g	White or Blue		6260		I
STY102	Cart102	MM	C	2.0g	Blue, White or Red		6410		I
STY103	Cart103	MM	C	2.0g	Orange or Black		7530		I
STY104, 114	Cart104, 114	IM	C	2.5g	Grey		574		I
STY105, 115	Cart105	VM VM	C E	3.5g 2.5g	Yellow or Blue Green		608 608E		I J
STY107 STY108	Cart107 Cart108	MM MM	C C	2-2.5g 2-2.5g	Lt Green or White		539 539		I I
STY113	Cart113	CE	SR	6.0g	Metal		325		C
STY116, 120	Cart116	MM	C	2.0g	Red or Blue		1097		I
STY117	Cart117	MM	C	3.0g	Grey		1143	505	I
STY118	Cart118	VM VM	C E	3.0g	Grey Green		1090 1071E	1071	I J
STY121		VM	C	3.0g	Black or Yellow		1114		I
STY122		MM	C	2.0g	Beige or Blue		564		I
STY123		VM	C	3.0g	Black		1167	1155	J
STY124		VM	C	2.5g	Black		1168		J
STY127		MM	C	2.5g	Red or Black		1184		I
STY128		MM	C	1.5g	Black		1192		I
STY129		VM	C	3.0g	Black		1181		J

SHARP

Original Stylus Number	Original Cartridge Number	Cart-ridge Type	Stylus Tip	Tracking Force	Colour	Diagram	STYLUS		Price Code
							No.	or use:	
STY130		VM VM	C E	3.0g 2.0g	Black Green		1071 1071E	1090	I J
STY131		VM VM	C E	1.3g 1.3g	Ivory Green		1177 1177E		J K
STY132		CE	C	3-4.0g	Black		177		F
STY133, 139		VM	C	3.0g	Black		1181		J
STY134		CE	SR	6.0g	Metal		325		C
STY135	Cart135	MM	C	1.25g	Black		1218		I
STY136, 137		MM	C	2.0g	Red, Blue or White		1097		I
STY138, 140 STY141, 142 STY163		VM VM	C C	2.0g 2.0g	Yellow or Red Green		1155 1155E		J K
STY143 STY147, 149 STY161	Cart143	MM MM	C C	1.25g	Blue or Grey Red		1243 1208		I I
STY144		MM	C		Black		1246		J
STY145		IM	C		Grey		1281		J
STY146 STY156, 159	GSTV5-8	CE	C	4.0g	Red		1260		I
STY148, 155 STY160		VM	C	2.5g	Yellow or Grey		1304		J
STY150		MM	C		Red		1263		I
STY154		CE	C		Red or Grey		1279		I
STY158 STY162		MM	C		Red		1299		I
STY201D		MM	C	3.0-4.0g	Green or Black		161		I
STY202, 213		VM VM	C C	2.5g	Grey Red or Blue		197 1004E		I J
STY450	Cart450	CE	C	5.0g	Black		179		F
STY550		MM	C	2.0g	Green or Blue		6410		I







SHARP

Original Stylus Number	Original Cartridge Number	Cart-ridge Type	Stylus Tip	Tracking Force	Colour	Diagram	STYLUS		Price Code
							No.	or use:	
STY701	Cart701	MM	C	3.0g	White		534		I
STY703	Cart703	VM VM	C E	2.5g 2.5g	Beige Red or Blue		197 197E		I J
STY704	Cart704	CE	C	5.0g	Ivory		164	594	I
STY705 4N2	Cart705 4C2	MM MM	C QD	3.0g 2.5g	Blue or Orange Blue		524 555QD		I L
STY706	Cart706	CE	C	4-6.0g	Black		557		I
STY707	Cart707	CE	C	3-4.0g	Black		194		F
STY717	Cart717	CE	C	6.0g	Black		601		I
STY750	Cart750	MM	C	2.0g	Blue		545		I
STY751 STY752	Cart751 Cart752	MM MM	QD C	2.0g 2-2.5g	Blue White		549QD 539		L I
		MM MM	C 78rpm	1.5-3.0g 1.5-3.0g	Beige Green		414 414-3		I J
ST4 ST4		CE CE	SR/2 SR/78		White White		88/2 88/78	442/2 442/78	C C
ADS		CE CE	SR/2 SR/78		Black Black		444/2 444/78		C C
DSN45		CE	C		Black		1022		F
		MM	C	2.0g	Blue		1209		I
Turntable/System No	Stylus No	Turntable/System No	Stylus No	Turntable/System No	Stylus No				
1620 CD302 CMS250, 750CD CMSR70CDX CP1600, 1900 CPV300 DX450 F10 F500 GS111 GS700 GS1500, 1950 GS2710 GS2900 GS4500 GS4520 GS4521 GS5002	1155 ? 1260 1243 1155 1114 1260 1246 1055 414 6410 325 88 165 164 534 414 545	GS5100 GS5400 GS5410, 5420 GS5430 GS5454 GS5500, 5510, 5550, 5560 GS5600 GS5610, 5620 GS5624 GS5630, 5631 GS5640, 5643, 5650 GS5644, 5654 GS5710, 5720 GS5721 GS5730 GS5800, 5810, 5820 GS5830 GS6400, 6500	194 325 179 194 179 or 194 88 or 194 165 179 197 444 179 or 164 179 165 or 160 197 179 524 601	GS8200, 9200 GSTV3, TV8 GSTV5 GSTV7 GX88 N15 RM240 RP8 RP10, 11, 21, 32 RP23 RP30 RP101 RP103, 107 RP104 RP105 RP111 RP112 RP113	540QD 1022 1260 1208 1155 1155 1246 1208 1143 1209 1097 1192 1181 1168 1097 1155 539 1192				





SHARP

Turntable/System No	Stylus No	Turntable/System No	Stylus No	Turntable/System No	Stylus No
RP114	1168	RP8120	608	SG550, 750	1260 or 1279
RP116, 117, 118, 126	1181	RP9100	608	SG650, 950	1304
RP155	1209	RPR5	1181 or 1184	SG1810	601
RP201	1208	RPS9	1208	SGF50	1260 or 1279
RP203	197	RPV500	1181	SGF500, 550	1279
RP205, 207	1246	DM215	1260	SGF650	1155
RP302	1155	RPW1	1184 or 1181	SM240	1246
RP303	1243	RPZ2000	1263	System46	1260
RP304	1155 or 1260	SC6900	1155	System103, 107	1181
RP307, 320	1155	SG1	1143	System111	1155
RP600	1299	SG45	1022	System116, 118	1181
RP666	1208	SG46	1260	Sustem160	1155
RP1000	524	SG143	180	System303	1243
RP1030	6260	SG155	557	System304, 320, 650	1155
RP1122	539	SG160	325	System2000	1263
RP1133	197	SG165	498	System2526	1155
RP1144	574	SG170, 180	325	VZ1500, 1550, 1600	1304
RP1266, 1288	1097	SG181	601	VZ1610, 1900, 2000	1304
RP1500	325	SG220	608	VZ3000	1114
RP1818, 2727	539	SG221	6260	VZ3500	1304
RP3500	197	SG270	1143	VZN15	1304
RP4500	1304	SG450	574	VZV3	1114
RP5100, 5200, 7100	608	SG500	1279	VZV4	1168
RP7800	1208	SG500H	197		

SHERWOOD

Turntable or System Number	Cart-ridge Type	Stylus Tip	Tracking Force	Colour	Diagram	SOUNDRING		Price Code
						No.	or use:	
DM215	CE	C		Red		1260		I
IM2893CD, ST1004, 1020 PD411, 608, 701, 702, 724, 728 PD801, 913, 7018, 7028 ST870, 1010, 1018, 1028, 1620	VM VM	C E	2.5g 2.5g	Yellow Green		1155 1155E		J K
PD301, 802 System 21, 25	MM	C		Lt Blue or Red		1258		I
PM9800	MM	C		Red		1299		I
PS 9700 ST 891	VM VM	C E	1.3g 1.3g	White or Blue Green		1177 1177E		J K
ST 880, 890	MM	C	3.0g	Orange		1224		I

SHURE

A53, 55	PC12	CE	C		Metal		208		C
N 3 D, 7 D, 8D	M 3, 7, 8	CE	C	3.0-6.0g	Gold		269		C
N 21D	M 21	CE	C	1.5-2.5g	Gold		290		C
N 17 CM	C17M, Jukebox	MM	C	5.0g	Lt Blue		1095		I











SHURE

Original Stylus Number	Original Cartridge Number	Cart-ridge Type	Stylus Tip	Tracking Force	Colour	Diagram	STYLUS		Price Code
							No.	or use:	
N44C Imp.	M44C	MM	C	3.0-5.0g	LtBlue		424	387	I
N44-3 N44-7 Imp	M44-3 M44-7	MM MM	78rpm C	1.5-3.0g 1.5-3.0g	Green White		387-3 387	424	J I
N55E	M55E	MM	E	0.75-2.0g	Yellow		425E		J
N70B, 72B N70EJ, 72EJ N70-3, 72-3	M70B, 72B M70EJ, 72EJ M70-3, 72-3	MM MM MM	C E 78rpm	1.5-3.0g 1.5-3.0g 1.5-3.0g	Beige Lt.Green DkGreen		6890 6890EJ 6890-3		I J J
N75-3 N75-6/Mk.II	M75-3 M75-6/Mk.II	MM MM	78rpm C	1.5-3.0g 1.5-3.0g	DkGreen Beige		414-3 414	454	J I
N75C R7C, RM9300	M75C	MM	C	3.0-5.0g	Blue		498	414	I
N75ED/Mk.II	M75ED/Mk.II	MM	E	0.75-1.5g	Black		456E		J
N75G	M75G	MM	C	0.75-1.5g	DkGrey		454	414	I
N77	M77	MM	C	3-6.0g	Black		326		G
N91-3 N91ED N91GD N93E	M91-3 M91ED M91GD M93E	MM MM MM MM	78rpm E C E	1.5-3.0g 0.75-1.5g 0.75-1.5g 1.5-3.0g	DkGreen Yellow Red LtGreen		186-3 186ED 186 186E		J J I J
N92E	M92E	MM	E	1.25g	Red		1237E		J
N99E	M99E	MM	E	1.25g	Blue		1238E		J
N104E, RXP3 N110HE	M104E M110HE	MM MM	E HE	1.25g 1.25G	Yellow White		1248E 1248E		J J
N95ED R9000E N95HE	M95ED High Track M95HE	MM MM	E HE	0.75-1.5g 0.75-1.5g	Yellow Black		606ED 606HE		J K
N97HE, RXT4	M97HE	MM	HE	0.75-1.25g	Black		1275HE		L
SS35C	SC35C	MM	C	4.5-5.0g	LtBlue		1152		I
VN15E	V15/II	MM	E	0.75-1.5g	Black		532E		J
VN35HE	V15/III	MM	HE	0.75-1.25g	Black		541E		J
VN45HE	V15/IV	MM	HE	0.75-1.5g	Black		1039HE		L





SILVER

Turntable or System Number	Cartridge Type	Stylus Tip	Tracking Force	Colour	Diagram	STYLUS		Price Code
						No.	or use:	
SL30C, 300 System 300, 301	MM	C		Orange		7450		I
SL90	MM	C		Blue		1209		I
SL201 System 200, 201, 251	MM	C	2.5g	Beige		564		I
SL500, 550,	VM VM	C E		Yellow Green		1155 1155E		J K
SL550	MM	C		Black		1081		I
SL770	MM	C		Red		1299		I
SL1010, 1020 SLU30, 50 System 66, 70, 71, 76, 171	MM	C		Red		1060		I
SL1011	IM	C	3.0g	Red		1179		I
SL 1500, 5005 SS 5005E, 6000	MM	C		Green or Blue		545		I
SL2004, 2005	CE CE	SR/2 SR/78		White White		88/2 88/78	442/2 442/78	C C
SS 80, 88 System 80, 95	MM	C		Red		1184		I
SS94, 3850, 8300 System 83,	CE	C		Black		1022		F
SS150, 200	CE	C	4.0g	Red		1260		I
SS 1000, 1005, 1015, 1100, 1405 SS 3500, 3530, 3533, 4030 System 350	CE	SR/2 SR/78		White White		475/2 475/78	499	C C
SS1405	CE	SR		Metal		325		C
SS 1471	MM	C E	1.0-2.0g 1.0-2.0g	Blue Blue		1091 1091E		I J
SS 3000 System 300	CE	C		Black		179		F
SS 3050, 3700	CE	C		Black		1055		F
System 80, 90, 91, 96, 100, 101	MM	C	2.0-2.5g	Green		539		I
System 1500, 1501	MM	C		TrBrown		184		I

SONOTONE

Original Stylus Number	Original Cartridge Number	Cart-ridge Type	Stylus Tip	Tracking Force	Colour	Diagram	STYLUS		Price Code
							No.	or use:	
2T		CE	LP/LP		Gold		33		C
8TA		CE CE	SR/2 SR/78		Gold Gold		82 82/78		C C
9T 9TA 9TAHC 16T 18T		CE CE CE CE CE	SR/2 SR/2 SR/2 SR/2 SR/2		Grey Grey Grey Yellow Yellow		263 332 328 295 296		C C C C C
21T		CE	SR/2		Yellow		342		C
23T		CE	SR/2		Yellow		423		C
24T		CE	SR/2		Yellow		447		C
25T, 28T		CE	SR/2		Yellow		369		C
ASS, ADS BSS, CSS	3509 3549, 3559	CE CE	SR/2 SR/78		Black Black		444/2 444/78		C C
GSS1, GDS1 GSS2, GDS2	2109, 2139 2509 2529, 2539	CE CE	SR/2 SR/2		Black Grey		445 446		C C
V100, 101		MM	C	2.3g	Black		6870		I
V200E V200S		MM MM	E C	2.3g 2.4g	Red Blue		173E 170		J I

SONY

ND5G ND7E	VL5	VM VM	C E	2.0g 2.0g	Yellow Green		1070 1085E		I J
ND14G	VL14GS	MM	C	2.0g	Red		1059		I
ND15G	XL15	MM	C	1.2-2.5g	Red		6380		I
NDST21	SC21M	CE	SR	7-8.0g	White		499	475	C
ND25E	XL25	MM	E	1-2.0g	Grey		7550E		J





SONY

Original Stylus Number	Original Cartridge Number	Cart-ridge Type	Stylus Tip	Tracking Force	Colour	Diagram	STYLUS		Price Code
							No.	or use:	
ND30E	XL30	MM	E	1.5g	Blue		1091E		J
ND33G	XL33S	VM	C	3.0g	Red		608		I
ND35E ND45E	XL35 XL45E	MM MM	E E	1.5g 1.5g	TrBrown TrRed		1046E 1046E		J J
ND50G	VX50	MM	C	3.5-4.5g	Orange		7060		I
ND50X, 70X	XL50, 70	MM	E	1.5g	TrOrange		1228E		J
ND60G		CE	C	4-5.0g	Red		1047		I
ND100G	VL100	IM	C	1.5-2.5g	Green		6240		I
ND108G	VX108	MM	C	2.0g	Red		539		I
ND113P	VM98	MM	C	3.0g	White		165		I
ND114P, 117P ND115G	VM10P, 15P VM11G	MM MM	C C	2.5g 2.0g	Red, Orange or Black		7560 7560		I I
ND116P	VX12P	CE	SR	6.0g	Metal		325		C
ND119P ND120P	VX17P	MM	C	5.0g	Green		509		I
ND121P	VM19P	MM	C	3.0g	Red		491		I
ND124P ND125P, G	MS12 VM21P	MM MM	C C	4.0g 3.0g	Red Black		492 492		I I
ND126P ND131G	VM22P VM1200G	IM IM	C C	1.5-3.0g 1.5-2.5g	Black Blue		493 493		I I
ND127P	VX23P	CE	C	4.0g	Red		511		I
ND128P	VX24P	CE	C	5-8.0g	Black		179		F
ND129G ND130G	VM25G VM25G	VM VM	C QD	2.0g 2.0g	Yellow Ivory		197 525QD		I L
ND132G	VM22G	IM	C	1.5-2.5g	Green or White		508	493	I

SONY

Original Stylus Number	Original Cartridge Number	Cart-ridge Type	Stylus Tip	Tracking Force	Colour	Diagram	STYLUS		Price Code
							No.	or use:	
ND133G ND134G	VL30G VM32G	VM VM	C C	2.0g 2.0g	Green Red		7630 7630		I I
ND135G	VM27G	MM	C	2.0g	Red		552		I
ND136G		VM	C	3.0g	Orange		608		I
ND137G	VL37G	VM	C	2.0g	Yellow		1075		J
ND138G	VL38GSA	VM	C	2.5g	Red		1071	1090	I
ND139G, 144G	VL44G	VM	C	1.5g	Black		1175		J
ND142G, 155G	VL42G	VM	C	2.0g	Yellow		1155		J
ND143G	VL43GS	VM	C	1.8g	TrBlue		1182		J
ND145G	VL45G	VM	C	1.3g	Grey		1177		J
ND146G		CE	C	4.0g	White		1153		I
ND147G	VL47GS	VM	C	3.5g	Grey		1090	1071	I
ND148G	VL48G	MM	C		LtBLue		1258		I
ND150G	XL150	MM	C	1.8g	TrRed		1052		I
ND152P	VX52P	CE	C		Grey		1260		I
ND153G		VM	C	2.0g	Black		1168		J
ND200G, 250G ND200E, 250E	XL20G CL20, XL250E	MM MM	C E	1.0-2.0g 1.0-2.0g	Blue or TrRed Blue or Yellow		1091 1091E		I J
ND220G	VL20G	MM	C	2.0-4.0g	Red		1082		I
ND300G	XL300G	MM	C	1.25g	Orange		1273		I
ND301P		CE CE	SR/2 SR/78	4.0g 4.0g	White White		88/2 88/78	442/2 442/78	C C







SONY

Original Stylus Number	Original Cartridge Number	Cart-ridge Type	Stylus Tip	Tracking Force	Colour	Diagram	STYLUS		Price Code
							No.	or use:	
NDMM1	XLMM1	MM	C	1.2-1.8g	TrOrange		1271		I
CN234, 251	PSJ10	MM	C		Red		1299		I
Vacolux		CE	C		Metal		325		C
Stylus 5E	OMP5E	MM	E	1.25g	Black		1229E		J
Turntable/System No	Stylus No	Turntable/System No	Stylus No	Turntable/System No	Stylus No				
CN234, 251	1299	HP300, 301	492	PS311, 320	1155				
Compact 19, 27, 28, 40, 48	1155	HP310, 318, 319, 419	511	PS313	1059				
Compact 49, 58, 74, 76, 87	1155	HP450, 460, 465, 466, 475	7560	PS313A	563				
DP2000	491	HP480, 485, 488	7560	PS333, 343	179				
EX1, 2	6240 or 7060	HP500, 600	493	PS350	1052 or 1071				
EX10	7060 or 608	HP501, 520	492	PS434	1075				
EX30	608	HP510, 511	508 or 7560	PS454	1070				
EX100	499	HP550	165	PS515, 636, 700	563 or 6380				
EXM1, 2	1071	HP580	197	PS535	563 or 6380				
EXD550W	1155	HP610	7560	PS550	1294				
FJ5000	508	HP620	492	PS600	552				
FQ3000, 7000	508	HP710	511	PS1000	491				
FQ5000, 6000	492	HP800	509	PS1010	7560				
Gemini	508	HP810	563	PS1100, 1150	508 or 563				
GL1, 2	6380	HP2200, 3000	492	PS1200	7560				
HME118, 228	1047	HP4000	493	PS1350	563 or 552				
HME338	608	HP4100, 5000, 5100	492	PS1450, 1700	563				
HME418	511 or 563	HP8000	7560	PS1800	7560				
HMF334	608	HPS6000	492	PS2100	492				
HMK11	608	JJ50, 500, 505, 700, 707	1071	PS2250, 2300, 2310	508				
HMK20	179	JJ3002	1071	PS2350	563				
HMK30, 40, 50, 55, 70, 77, 80	563	LBT250, 555	1229E	PS2400	508				
HMK33, 44, 120	608	LBTV701	1155	PS2410	493				
HMK119, 229	1047	LQ3000, 3100K, 5000	508	PS2500, 2510	508				
HMK313, 414	1071	LQ7000	508	PS2700, 3300	563 or 6380				
HMK339	608	LX1, 2, 3K	7060	PS2800, 3000	552				
HMK419	563 or 511	Mariner II	508	PS3700, 3750, 4300	6380				
HMK515	1090	MJ100, 200, 210	179	PS4350, 4750	563 or 6380				
HMK700	563	MJ300	492	PS5100, 5170	508				
HMK3000, 3030, 5000	1071	MJ500, 550	179	PS5190	492				
HMK7000, 9000	563	MQ100	197	PS5520, 5550, 6750	508				
HMP20	179	Pisces	508	PSD705	1155				
HMP40, 50, 70	563	PLX2	1052	PSF3	1258				
HMW20	179	Prec V7	1294	PSF5, 9	1175				
HP17	88	Prec V10, 11, 30, 33	1182	PSFL1	1052				
HP30	492	Prec V77	1294	PSFL3, 5	1091				
HP50	179	PS03	1182	PSFL5C	1070				
HP100, 101, 110, 122	325	PS7, 10	563 or 6380	PSFL77, 99	1052				
HP120, 155	509	PS11	563 or 1059	PSFL77C	1177				
HP140, 148, 149	499	PS20, 33, 44	1294	PSJ20	1299				
HP150	508 or 509	PS22	563	PSLX1	1071				
HP151, 160	325	PS48, 50, 110, 122	325	PSLX2, 3	1052				
HP161, 168, 169	499	PS111, 180	539	PSLX2C, 3C, 5C	1070				
HP170, 178, 179	511	PS120	179	PSLX4, 5, 7	1091				
HP180	165 or 5560	PS150, 155	1071 or 1155	PSLX10, 20	1182				
HP188	509 or 7560	PS160	325	PSLX22, 24, 25	1052				
HP200, 201, 202, 210	492 or 509	PS200	1155	PSLX30	1182				
HP210A	511	PS210	608	PSLX33, 35, 50	1052 or 1155				
HP211	511 or 7560	PS212	1059 or 608	PSLX40, 43P, 45, 47P	1155				
HP215, 218	509	PS222	509	PSLX49P, 52P	1299				
HP219	509 or 511	PS230	508	PSLX50, 52	1155 or 1299				
HP220, 238, 239	511	PS242	1075	PSLX55	1052				
HP239A	7560	PS250	165 or 1052	PSLX56	1299				
HP250, 258, 279	511	PS252	1071	PSLX60	1059 or 1155				

SONY

Turntable/System No	Stylus No	Turntable/System No	Stylus No	Turntable/System No	Stylus No
PSLX62, 66, 70, 100, 155	1155	PSP7X	6380	SQ3000, 4000, 4100	493
PSLX150	1299	PSQ3, 7	1182	SQP3, 7	1182
PSLX200, 220, 231, 250, 285	1155	PST1, 15	6380 or 552	SQP20	493
PSLX295, 300, 310, 311, 320	1155	PST20, 25	563 or 6380	SQP400	511
PSLX300	1299	PST22	6380 or 1070	System 28	1155
PSLX330	1182	PST30, 33, 363, 636	6380	V7, 77, 200, 500	1052
PSLX350	1052	PSV33FR	1273	V100, 3002	1071
PSLX410	1091	PSV901	1155	Virgo II	508
PSLX430	1177	PSX2, 3, 4, 6, 7, 22, 30	6380	XOD1, 5, 8, 201, 301	1155
PSLX431	1155	PSX33, 35, 40, 45, 50	6380 or 1091	XOD501, 550	1155
PSLX500	1052	PSX50W	7550	XOG50	7560
PSLX500C	1177	PSX55, 60, 65, 75	6380 or 1091	XOV500	1260
PSLX520, 550	1273	PSX500, 555, 600	1091	YJ200, 201, 300, 301	492
PSLX700	1155	SH7/II	1182	YJ600	492
PSLX770, 910	1273	SL10	1071	Z7	508
PSLX4002, 6002	1052			Z2000, 3000, 5000	1155

STANTON

Original Stylus Number	Original Cartridge Number	Cartridge Type	Stylus Tip	Tracking Force	Colour	Diagram	STYLUS		Price Code
							No.	or use:	
D5107A/II D5107A D5127	500A/II 500A 500-3	MM MM MM	C C 78rpm	2.0g 2-5.0g 2-5.0g	Blue Black-Yellow dot White-Blue dot		1289/II 1289 1289-3		I I J
D5107AL D5107AL-Flu	500AL 500AL	MM MM	C C	3-7.0g 3-7.0g	White-Aqua dot Fluorescent		1289AL 1289Flu		J J
D5100E	500E	MM	E	2-5.0g	Black-Red dot		1289E		J
D6071A D6004E	600A 600E	IM IM	C E	3.0g 3.0g	Black Black		1171 1171E		I J
D6807A D6800E D6800EE D6800EEE D6800EL D6800EEE-S	681A 681E 681EE 681EEE D681EL 681EEE-S	IM IM IM IM IM IM	C E E E EL QD	1.5-3.0g 0.75-1.5g 0.75-1.5g 0.75-1.5g 0.75-1.5g	Black Black Black Black White Black		6610 6610E 6610EE 6610EEE 6620EL 6610QD		I J J J J L
D81	881S	IM	QD	0.75-1.25g	Black		1106QD		L
D71EE	L720	MM	E	1.25g	Black		1305E		J

SUPRAPHONE

VK4302		CE	SR/2	5.0g	Red		6200		C
--------	--	----	------	------	-----	--------------------------------------------------------------------------------------	------	--	---

TANNOY

Mark II		CE	SR		Metal		258		C
---------	--	----	----	--	-------	--------------------------------------------------------------------------------------	-----	--	---













T-HOLDER

RPX		CE	SR		Metal		227		C
-----	--	----	----	--	-------	--------------------------------------------------------------------------------------	-----	--	---

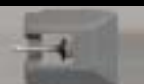

TEAC

Turntable or System Number	Cart-ridge Type	Stylus Tip	Tracking Force	Colour	Diagram	STYLUS		Price Code
						No.	or use:	
ACE 7 System P 7, 9	MM	C		LtGreen		539		I
APB 360 BD 65, 80 CR 500, 700 JC 70 Midi 1000 P 45, 90, 365, 367, 380, 480, 690 PJ 51, 61, 470, 480, 690 PS 50 SP 1000, 3000 ST 320, 610	VM	C	1.3g	White		1177		J
	VM	E	1.3g	Green		1177E		K
BD 95 JC 40 P 75; T 75	MM	C		Red		1299		I
CD 1200 CR 660, 900 SP 1000, 3000; T 470	MM	C		Red		1241		I
CG 7700 CSP 208, 308, 3500 JC 75 N 595, 707 P 190, 305, 440, 707, 708, 988 PS 708, 900 SS 700, 800	VM	C		Yellow		1155		J
	VM	E		Green		1155E		K
Clarity 88, Commander Concert 60, CR 500 PX 7, 100, 300 Series 45, SR 500	MM	C		Red		1184		I
CR 300, 400, 450 N 313 P 55, 313; PX 50 SS 300, 400, 500	MM	C	3.0g	Orange		1224		I
DCD 2750; JC 12, 19 JC 200, 300,403 MXD 12, 30, 32 P 37	CE	C		Red		1307		I
DCD 2830, 2930 JC 10, 15, 16, 20, 22, 30, 32, 35 JC 39, 40; MXD 10 P 35, 90	CE	C		Red		1260		I
JC 40, 45, 50	MM	C		Red		1190		I
	MM	E		Blue		1190E		J
	MM	"78"		Red		1190-3		J
JC 60; M 22 P 390	MM	C		Red		1208	1243	I
P 7, 9 PS 300, 500 PX 50, 300	VM VM	C E		Beige Green or Blue		197 1004E		I J
P 50 TSF 8001A	MM	C		Black		1081		I
P 70	VM	C		Yellow		608		I
	VM	E		Green		608E		J
P 315, 515	VM	C		Red		1071	1090	I

TEAC

Turntable or System Number	Cart-ridge Type	Stylus Tip	Tracking Force	Colour	Diagram	STYLUS		Price Code
						No.	or use:	
P 360, 476, 496	VM VM	C E	2.0g 1.5g	Red Caramel or Red		1226 1196E		J K
P 470 PT 495	IM	C	1.25g	Black		1278		I
PS 270	MM	C		Red or Black		552		I
PX 50, 270/II, 550	MM	C	2.0g	Black or Blue		1096		I
PX 270, 272, 3000 TSF 3300	MM	C		Blue		579		I
ST 215 P380	MM MM	C E		Black Black		1295 1296E		I J
ST 510	MM MM	C E		Black Black		1092 1229E		I J
TS 2705	MM	C		TrBrown		184		I
TSF 30, 50	MM	C		Orange or Blue		524		I
TSF 3300	MM	C	1.5g	TrGreen		1172		I
TSF 8003	VM	C	2.0g	Grey		1232		I
VD 80	IM	C	1.25g	Clear		1215		J







TECTRON

N 512 S	T 512 S	MM	C	1.5-2.5g	Tr Yellow		1067		I
N 812 S	T 812 S	MM	C	1.5-2.5g	Tr Blue		1078		I
N 712 S	T 712 S	MM	C	1.5g	Tr Yellow		1100	616	I

TEMPEST

TF 3000	CE	C		Red		1307		I
VIP 380	MM	C		Blue		1243	1208	I

TELEFUNKEN

Original Stylus Number	Original Cartridge Number	Cart-ridge Type	Stylus Tip	Tracking Force	Colour	Diagram	STYLUS		Price Code
							No.	or use:	
A 10, 20/2	T 20/2	CE	SR/2	5.0g	Metal		69		C
A 23/2		CE	SR/2		Grey		394		C
A 200/1		CE	SR/2		Metal		267		C
A 400		MM	C	2.0g	Black, White or Orange		1015		I
A 600 D		VM VM	C E	1.5g 1.0g	White or Brown Burgundy		1101 584E		I J
TTSA		CE	LP		Metal		34		C

TELETON

MST 5		MM	C		Lt Green		534		I
MST 31		MM	C		Orange		7450		I
N 1520		MM	C		Dk Blue		1209		I
RP 150		MM	C		Tr Red		505	1143	I
T 380, 830		MM	C		Red		1184		I







TENOREL

N 2001D	T 2001D	IM	C	2.2g	White		1312		J
---------	---------	----	---	------	-------	--------------------------------------------------------------------------------------	------	--	---



TEPPAZ

ECO 60		CE	LP		Metal		72		C
Stereo		CE	SR		Metal		73		C
ECO 60/432		CE	SR/2		Grey		402		C
MT 30		CE	SR/2		Black		477		C

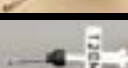
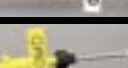
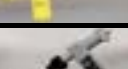





TETRAD

Original Stylus Number	Original Cartridge Number	Cart-ridge Type	Stylus Tip	Tracking Force	Colour	Diagram	STYLUS		Price Code
							No.	or use:	
32		CE	SR		Yellow		375		C
33		CE	SR		Black		376		C
51		CE	SR		Black		520		C
53		CE	SR		Black		521		C
T 2/MD		CE	SR		White		1132		C
T 3M/D		CE	SR		Yellow		1132		C
T 20 M/D		CE	SR	3.2g	White		1109		C
T 30 M/D		CE	SR	4.0g	Yellow		1193		C
T 50 M/D		CE	SR	5.5g	Grey		1194		C





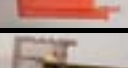

THOMPSON

Pathe MUC	MM	C	2.5-3.5g	Red		1263		I
Pathe Soundburg	MM	C		Red or Blue		1258		I
Pathe ST35	VM VM	E C		Green Red		1071E 1071	1090	J I

THORN

RG 107, 108, 109, 110, 111, 112 RG 113, 114, 115, 506, 1409 RG 1410, 4382, 5081	CE	SR/2 SR/78		White White		88/2 88/78	442/2 442/78	C C
RG 1441, 1442 RP 76	MM	C		Black		6270		I
RG 1441, 1442, 1444	CE	C		Black		1022		F
RG 1443	CE	C		Metal		325		C
RG 4027	MM	C		Tr Yellow		1100	616	I
RG 4034, 4037 System 403	MM	C		Orange		7730	7480	I
RG 4047, System 404	MM	C		TrBrown		184		I

THORN

Turntable or System Number	Cart-ridge Type	Stylus Tip	Tracking Force	Colour	Diagram	STYLUS		Price Code
						No.	or use:	
S 18, 20, 26	CE	C		Blue		594	164	I
S 23 SM 32	CE	C		Red or White		1153		I
S 24, 25, 28, 34	MM	C		Red		1208	1243	I
SG 117, 118, 119, 120, 121, 122 SG 123, 1408, 1409, 1410, 1411 SG 1412, 1413, 1414	CE	SR/2 SR/78		White White		442/2 442/78	88/2 88/78	C C
SP 2511	CE	SR/2		Yellow or Grey		332/2	328/2	C
SRA 25	MM	C		Tr Green		1151		I

TOSHIBA

NN1C	N 01C	CE	C	4.0g	Black or Green		459		C
N 3 CD	C03C, 10C	CE CE	SR/2 SR/78	4.0g 4.0g	Black Black		166/2 166/78		C C
NN 3 C	N03C	CE	C	3.0-4.0g	Black		194		F
NN 4 C	C07M	MM	C	3.0-4.0g	White		165		I
NN 11 C	C22C	CE	C	3.0g	Blue		594	164	I
NN 12 C	C26M	MM	C	3.5g	Green or White		180		I
NN 13 D	C27M	IM	C	3.0g	White		508	493	I
NN 14 C	C29, 35	CE	C	3.0g	Ivory		164	594	I
N 6 C		CE	C	6.0g	Metal		325		C
N 16 D		VM VM	C E	2.5g 2.5g	Yellow or Red Green		1155 1155E		J K
N 17 D		IM	C	3.0g	Red		1179		I
N 20 C	C21	CE	C	4.0g	White		1138		F

TOSHIBA

Original Stylus Number	Original Cartridge Number	Cart-ridge Type	Stylus Tip	Tracking Force	Colour	Diagram	STYLUS		Price Code
							No.	or use:	
N 21 C	C 21	CE	C	4.0g	Red or White		1153		I
N30C	C30M	MM	C	1.25g	Red or Blue		1256		I
N32M	C32M	VM VM	C E	1.3g 1.3g	White Green		1177 1177E		J K
N33C	C33M	MM	C	1.5g	Black		1144		I
N34C N35DY, 68c	C34M C35M	MM MM	C C	1.25g 1.25g	Orange, Blue or		1203 1203		J J
N36C N37C	C36 C37M	MM MM	C C		Red or Blue		1258 1258		I I
N40C N41D	C40M SM404C	CE	SR	3.0-4.0g	Black		1055		F
N44C		MM	C	1.5-2.0g	Black or White		1036		I
N45C		MM	C		Orange		1208	1243	I
N48C	C48	MM	C	2.0g	Blue		1209		I
N50C, 51C N51E N51-3	C51M/II C51M/II-E C51M/II-78	MM MM MM	C E 78rpm	2.5g 2.5g 2.5g	Red Blue Red		1190 1190E 1190-3		I J J
N52, 53DY N59DY	C52M	VM VM	C C	2.5g 2.5g	Yellow or Beige Green or Blue		197 1004E		I J
N55, 56, 57DY	C55M	VM VM	C C	2.0g 2.0g	Yellow Green		608 608E		I J
N58C	C58M	MM	C	2-3.0g	TrBlack		1010		I
N60DY, 70, 71		VM VM	C C	2.0g 2.0g	Red Green		1071 1071E		I J
N60, 61C		CE	C	4.0g	Red		511		I
N62, 66C N64, 69C	C62, 66M C64M	MM IM	C C	1.5-2.0g 1.5-2.0g	DkRed DkRed		1183 1183		I I
N72		VM	C	1.5g	Black		1187		J
N73C		CE	C	4.0g	Red		1260		I

TOSHIBA



Original Stylus Number	Original Cartridge Number	Cart-ridge Type	Stylus Tip	Tracking Force	Colour	Diagram	STYLUS		Price Code
							No.	or use:	
N74, 75C, 76D		MM	C	1.25g	Grey		1242		I
N77		MM	C		Yellow or Red		1208	1243	I
N78D	C78M	VM	C	2.2g	Black		1181		I
N160C	C160M	MM	C	2.0g	Red or Blue		1097		I
N210C N210CX	C210M C230M	MM MM	C E	1.2-1.8g 1.2-1.8g	Red or Blue Red		579 603E		I J
N220		IM	C	2.0g	Olive		7470		I
N225		MM	C		Orange		7450		I
N250, 260C	C250, 260M	MM	C	1.5-2.0g	Red or LtGreen		539		I
N270C N280, 290C	C270M C280, 290M	MM	C	1.5-2.0g	White or Black		1036		I
N272, 292C		MM	C	2.0-3.0g	Red		1184		I
N293DY		VM	C	3.5g	Grey		1090	1071	I
N300C	C300F	CE	C	1.5-2.0g	Metal		183		F
N301C	C301F	CE	C	2.0g	Silver		507		I
N310C	C310M	MM	C	1.5-2.0g	Red		1161		I
N320,330,340N	C320,330,340M	MM	C	1.5-2.0g	Tr Green		1151		I
N500C, 550/II N500E,550CEX	C500M, 550/II C500/E, 550E	MM MM	C E	1.5-2.0g 1.0-2.0g	Transparent Transparent		1049 1142E		I J
N501C	C501M	MM	C	2.0g	Red		1060		I
		CE	C		Black		570		F
		CE	C		Black		1022		F
		CE	SR		White		499	475	C

TOSHIBA

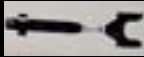

Turntable/System No	Stylus No	Turntable/System No	Stylus No	Turntable/System No	Stylus No
FR410	579	SM3180	1036	SR310, 350, 410	579
FS2000	166	SM3200	197	SR330, 335, 430	608
FS2500, 2600	325	SM3350	1010	SR510, 900	deleted*
FS3100, 4500, 5000	166	SM3500, 3600, 3650	197	SR520	165
FS6300,7300,7500,7700	166	SM3700, 3750	608	SR3617, 3639	1190
FX424, 434, 525, 535	508	SM4750	1036	SRA25	1151
FX636, 760, 795, 860	508	SM5200	197	SRA110, 115, 200	1036
FX5000	508	SM7000	499	SRA230	608
GP17, 23, 27, 28	325	SP403	508	SRB2, 20, 22, 30	1183
GP33	166 or 194	SP480, 505, 515	507	SRB3468	1190
GP28, 50, 55, 66, 71, 75	325	SP525, 535, 636	508	SRD32	1183
GP103, 752	325	SP606	507	SRD45	1071
GS5550	570	SP640	180 or 507	SRF3, 5	1071
GS5610	179	SP680C	507	SRF4	1209
MS35	166	SP680CD	499	SRF30, 225, 325	1036
MS40, 70	165	SP690	508	SRF330, 430, 530	608
SB80	183	SP707, 717	507	SRF335	539
SE470	459	SP727	deleted	SRF440, 550	1036
SL3127, 3147	1260	SP740	183 or 507	SRL5, 7	511 or 1153
SL5, 6, 7	1153	SP760, 795	508	SRL70	1187
SL77	511 or 1153	SP770, 790, 818	183	SRL75	1203
SLL8UW	511 or 1153	SP775, 820	180	SRM70	1144
SM33	1022	SP830, 840, 850	183	SRN70	1187
SM33AD	166	SP929	deleted	SRP5, 50	1071
SM102, 110, 130	325	SP940, 950	183	SRP6, 7	deleted
SM200	1153	SP2000	180 or 183	SRQ65	1090
SM260, 270	325	SP2000C	499	SRQ440, 550, 630	1036
SM280, 290	594	SP6000	508	SRQ660, 770	1036
SM300	325	SP6060	507	SRV9, 12	1155
SM350	166	SP7000, 8000, 9000	deleted*	SRV10	1203
SM360, 380, 390	197	SR10	165	SRV11	1258
SM404	1022	SR25	1151	SRV17, 50	1190
SM500	165	SR30	1190	SRV22	1179
SM2100	325	SR40	183	SRV32, 52	1181
SM2200	197	SR45	1090	SRV51	1242
SM2680, 2750	1055	SR50, 80	deleted*	SX140	325
SM2600, 2700	325	SR70	1144	SX150	197
SM2770	499	SR110, 115	1036	SX170	507
SM2780, 2880	1060	SR132	1183	SX220, 2200	197 or 608
SM2850	1010	SR200, 210, 220	608	SX2000	197 or 507
SM2900, 3000	325	SR225	166	SYSTEM7, 8, 25	1036
SM2950	1010	SR230, 250, 255	608	SYSTEM22, 30	1183
SM3100, 3150	197 or 608	SR300	508	SYSTEM34,37,38,40	1036

Styli marked “*” are no longer available and we recommend a new cartridge be fitted!





TRAKTON

Turntable or System Number	Cartridge Type	Stylus Tip	Tracking Force	Colour	Diagram	STYLUS		Price Code
						No.	or use:	
KP 7475	CE	SR		Metal		35		C
MPS 700	CE	C		Black		1055	1022	F
TRD 195	VM VM	C E	2.5g 2.5g	Yellow Green		1155 1155E		J K



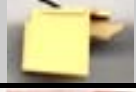









VACO

CN 60	CE	SR		White		383		C
Vaco-Lux	CE	SR		Metal		325		C











VOXON

Turntable or System Number	Cart-ridge Type	Stylus Tip	Tracking Force	Colour	Diagram	STYLUS		Price Code
						No.	or use:	
D 0170A, DJ 0170A TT 1010 VH 5, 10	VM VM	C E	2.5g 2.5g	Yellow Green		1155 1155E		J K
MD 100	CE	C		Red		1260		I
TT 444 VH 777	VM VM	C E	1.3g 1.3g	White or Blue Green		1177 1177E		J K
VH 1, 8, 24	CE	C		Black		1022	1055	F
VH 3	CE CE	SR/2 SR/78		White White		88/2 88/78	442/2 442/78	C C

YAMAHA

N102, 103		MM	C	2-3.0g	Grey		1208	1243	I
N3000	CG3000	MM	C	2.5g	White		165		I
N3500 N4000	CG3500	MM	C	3-4.0g	Grey		7580		I
N4500	CG4500	MM	C	2.0g	Black		552		I
N5000	CG5000	MM	C	2.5g	White		180		I
N5500	CG5500	IM	C	2.5g	White		508	493	I
N6500	CG6500	VM	C	2.0g	Grey		197		I
N6600	CG6600	VM	C	2.0g	Orange		1057		J
N6600S	CG6600S	VM	C	2.0g	Grey		608		I
N6700, 6900	CG6700	VM	C	2.0g	Grey		1090	1071	I
N6800	CG6800	MM	C	2.0g	Black or Blue		1096		I
N7000	CG7000	VM	C		Grey		1066		J
N7030	CG7030	VC	C	1.5g	Black		1200		L

YAMAHA

Original Stylus Number	Original Cartridge Number	Cart-ridge Type	Stylus Tip	Tracking Force	Colour	Diagram	STYLUS		Price Code
							No.	or use:	
N7700 N7800 N7900	CG7700 CG7800 CG7900	VM VM VM	C C E	2.0g 2.0g 2.0g	Red or Yellow Black Green		1155 1167 1155E		J J K
N8000	CG8000	VM	E	2.0g	Grey		1164E		J
N8010, 8200		VC	C	1.7g	Black		1239MC		L
N8100		VM	C	2.0g	Black		1181		J
N8300	CG8300	MM	C		TrBlue		1129		I
N8400	CG8400	MM	C		LtBlue		1221		I
Vaco Lux		CE	SR		Metal		325		C
		MM MM MM	C E "78"		Red Blue Red		1190 1190E 1190-3		I J J
N75-6/II		MM	C		Beige		414		I
VN35E		MM	E		Black		541E		J
Turntable/System No	Stylus No	Turntable/System No	Stylus No	Turntable/System No	Stylus No				
C1, 5 FS55, 555 GS20DX GS50 GS70DX MS3, 5 P05, 06, 07 P09 P4, 5, 6, 7 P17, 25, 27 P28 P31 P200, 220, 250, 300	325 197 or 1066 1066 508 1066 508 1155 1221 1090 1155 1229 1221 1090 or 1155	P320, 330, 350, 400 P450, 500, 520 P550 P700, 720 P750 P1520 PF30 PF800 PF1000 Series 100, 102, 105 Series 108, 633 SS3, 5, 30 SS40	1090 or 1155 1090 or 1155 1090 1155 1090 1155 1155 1190 1190 180 180 508 1066	SS60B YM30, 32, 33, 35 YM40 YM42, 43, 45, 48 YM50, 51, 53, 58 YM60, 61, 63 YM70 YP82, 84 YP400, 500, 700, 800 YP1000 YS30D YS50	1066 165 165 or 552 165 180 180 180 or 7580 1057 414 541E 1057 180				

Cross Reference: Goldring vs. Stanfield

Please note: Numbers up to 616 are identical

G/R	S/F	G/R	S/F	G/R	S/F	G/R	S/F	G/R	S/F	G/R	S/F	G/R	S/F	G/R	S/F
617	6170	711	7110	787	1039	865	556	953	1318	1030	1192	1106	1267		
618	6180	712	7120	788	1022	866	1032	954	1279	1031	1217	1107	1229		
619	6190	715	7150	789	1060	867	1035	955	1096	1032	1211	1108	1251		
620	6200	716	7160	790	1047	868	1086	956	1135	1034	1181	1109	1196		
621	6210	717	7170	791	1069	869	1103	957	1156	1035	1071	1110	1196		
622	6220	718	7180	792	1027	870	1038	958	1139	1036	1071	1111	1196		
623	6230	719	7190	793	1094	871	1038	959	1153	1037	1144	1112	1196		
624	6240	720	7200	794	1143	872	1005	960	1159	1038	1192	1113	1276		
625	6250	721	7210	795	1084	873	1037	961	1161	1039	1202	1114	1253		
626	6260	722	7220	796	1093	874	1104	962	1051	1040	1294	1115	1252		
627	6270	723	7230	797	1098	875	7400	963	1169	1041	1203	1116	1244		
628	6280	724	7240	798	1068	876	1108	965	1071	1042	1210	1117	1245		
629	6290	725	7250	799	6810	877	1136	966	1021	1043	1196	1118	1061		
630	6300	726	7260	800	1068	878	1049	967	1171	1044	1243	1119	1273		
631	6310	727	7270	801	1099	879	1142	970	6230	1045	1196	1120	1259		
632	6320	728	7280	802	1099	880	1049	971	1022	1046	1208	1121	1275		
633	6330	729	7290	803	1099	881	552	972	1052	1047	1146	1122	1175		
634	6340	730	7300	804	1100	883	1107	973	1162	1048	1246	1124	1240		
635	6350	731	7310	805	1067	884	1106	974	1141	1049	1219	1125	1297		
636	6360	732	7320	806	1078	885	1326	975	1001	1050	1185	1126	1071		
637	6370	733	508	807	6170	886	1104	976	1197	1051	1212	1127	1239		
638	6380	734	7340	808	1236	887	1088	977	1178	1052	1206	1129	1181		
639	6390	735	7350	809	1236	893	1048	978	1129	1053	1196	1130	1304		
640	6400	736	7360	810	1236	894	1236	979	1140	1054	1302	1131	1258		
641	6410	737	7370	811	1236	895	1075	980	1186	1055	1302	1132	1279		
642	6420	738	7380	812	1220	896	1125	981	186	1056	1199	1133	1274		
643	6430	739	7390	813	1300	898	1132	982	1151	1057	1223	1134	1278		
644	6440	740	7400	814	1300	899	474	983	1097	1058	1196	1135	1281		
645	6450	741	7410	815	1220	900	6200	984	1163	1059	579	1137	1288		
647	6470	742	7420	816	1070	901	1110	985	584	1060	1215	1139	1234		
648	6480	743	7430	817	1123	902	1137	986	1285	1061	1215	1140	1290		
649	6490	744	7440	818	1118	903	1087	987	1211	1062	1213	1142	1268		
650	6500	745	7450	819	1119	905	1076	988	1164	1063	1214	1143	1280		
651	6510	746	7450	820	1120	906	1076	989	1152	1064	1218	1144	1306		
652	6520	747	7470	821	1121	907	1061	990	608	1065	1130	1145	1260		
660	1095	748	7480	822	1124	908	1076	991	1089	1066	1182	1146	1266		
661	6610	749	7490	823	1124	909	1076	992	1164	1067	1209	1147	1263		
662	6610	750	7500	824	1124	910	1090	993	1165	1068	1221	1148	1295		
663	6610	751	7510	825	1061	911	1291	994	1071	1069	1222	1149	1299		
666	6660	752	7520	826	1057	912	1082	995	1187	1070	1201	1150	1190		
667	186	753	7530	827	1056	913	6700	996	1138	1071	1225	1152	1235		
668	170	754	7540	828	6750	914	1092	997	1198	1072	1177	1153	1307		
669	6690	755	7550	829	1269	916	1091	998	1155	1073	1241	1154	1309		
670	6700	756	7560	830	6830	917	1071	999	1166	1074	1226	1155	1308		
671	6710	757	1066	831	1270	918	1110	1000	1292	1075	1242				
672	1024	758	7580	832	7070	919	1207	1001	1159	1077	1073				
675	6750	759	7590	833	1003	921	1144	1002	1168	1078	7170				
677	6770	760	7600	834	1063	922	1086	1003	1170	1079	1256				
678	6780	761	7610	835	1058	923	1014	1004	1172	1080	1258				
679	6790	762	7620	837	1147	924	1092	1005	1195	1081	1026				
680	6800	763	7630	838	170	925	1081	1006	1157	1082	1327				
681	6810	764	7640	839	1009	926	1161	1007	1176	1083	6700				
682	6820	765	7650	840	1007	927	1073	1008	1167	1084	1227				
683	6830	766	7660	841	1064	928	1145	1009	1155	1085	1177				
687	6870	767	1015	843	569	929	1145	1010	1184	1086	1190				
688	6880	768	1037	844	569	930	1145	1011	1188	1087	1137				
689	6890	769	1046	845	1074	931	1146	1012	1160	1088	1180				
691	6910	770	1116	846	1074	932	1200	1013	1183	1089	1177				
692	6920	771	1122	847	1074	933	7070	1014	1173	1090	1246				
693	6930	772	7720	848	1074	934	1154	1015	1232	1091	1262				
694	6940	773	7730	849	1083	935	1204	1016	1085	1092	1271				
695	6950	774	1030	850	486	936	1096	1017	1189	1093	1228				
696	6950	775	7750	851	486	937	1109	1018	1190	1094	1184				
697	6950	776	7760	852	1131	938	1113	1019	1196	1095	1055				
698	6950	777	7770	853	1131	939	1159	1020	1166	1096	1247				
701	7010	778	1018	854	1029	944	197	1021	1179	1097	1249				
703	7030	779	6820	855	1111	945	1148	1022	1224	1098	1250				
704	7040	780	1134	856	1102	946	1114	1023	1085	1099	1237				
705	7050	781	7330	857	6700	947	1212	1024	1193	1100	1238				
706	7060	782	1059	858	1028	948	1158	1025	1194	1101	1248				
707	7070	783	1073	859	1025	949	1149	1026	1191	1102	1248				
708	7080	784	539	860	1027	950	1150	1027	1167	1103	1231				
709	7090	785	1010	861	1030	951	1316	1028	1070	1104	1231				
710	7100	786	1174	862	1031	952	1317	1029	1085	1105	1254				

Cross Reference: Soundring vs. Stanfield

Please note: Numbers up to 130 are identical

G/R	S/F	G/R	S/F	G/R	S/F	G/R	S/F	G/R	S/F	G/R	S/F	G/R	S/F	G/R	S/F
140	6210	400	400	515	177	626	6240	737	1073	861	6610	984	1159	1084	1310
156	156	402	402	516	516	630	6870	738	584	862	1056	985	1162	1088	1218
185	185	403	403	518	518	631	523	740	583	866	507	986	1145	1089	1239
186	186	404	404	519	519	632	6450	742	6820	873	1070	987	1216	1093	1219
202	202	407	407	520	1030	634	7300	743	7540	876	1057	989	1223	1094	1203
203	203	408	408	522	520	635	6230	744	1047	877	533	990	1151	1095	1236
204	204	411	411	523	6200	636	1111	745	1036	879	1084	991	1106	1097	1293
205	205	413	413	525	1031	637	1073	751	6330	882	594	992	1200	1099	1221
208	208	414	414	527	179	640	1030	754	7190	886	1095	993	1061	1100	1222
211	211	416	416	528	1312	641	1031	756	7210	892	1108	994	1076	1103	1232
216	216	418	418	529	481	643	6250	758	7220	893	7290	995	1173	1104	1227
224	224	419	419	530	609	644	6260	759	7230	894	1229	998	1160	1106	1237
227	227	423	423	531	6470	645	1015	760	7240	898	1229	999	1169	1107	1238
232	232	424	424	532	1326	646	6410	762	525	899	1229	1000	1164	1108	1248
233	233	425	425	533	187	647	7760	764	585	900	7070	1001	1157	1121	1271
234	234	426	426	535	170	648	6380	765	586	904	1060	1002	1176	1124	1229
235	235	427	427	536	1023	649	1059	766	586	906	1074	1003	1311	1125	1226
236	236	428	428	538	521	650	7690	767	502	908	1159	1005	1306	1127	1231
237	237	430	430	539	1024	651	553	772	6900	909	1027	1009	1178	1129	1242
247	247	431	431	540	556	652	509	773	7250	912	1062	1012	1187	1130	1241
258	258	434	434	541	6500	653	1019	774	7260	914	1069	1013	1156	1131	1243
262	262	436	436	542	508	654	6520	775	1003	915	1101	1014	1228	1132	1245
263	263	442	442	543	164	658	540	776	6910	918	7390	1016	1116	1134	1224
267	267	443	443	544	558	661	1019	778	6940	920	528	1017	1116	1135	1194
268	268	444	444	545	559	662	6930	780	515	921	1037	1018	1118	1136	1215
269	269	445	445	546	171	664	1058	781	611	922	1038	1019	1119	1137	1246
270	270	446	446	547	497	665	616	783	613	923	1037	1020	1120	1138	1247
279	279	447	447	549	481	669	576	789	6430	924	1104	1021	595	1139	1249
286	286	449	449	550	6270	670	1018	791	6300	925	1055	1022	595	1140	1250
288	288	450	450	551	6870	671	579	792	6170	926	1038	1023	1122	1142	1252
289	289	452	452	553	569	673	173	793	6180	927	1075	1028	1149	1143	1253
290	290	454	454	554	504	675	1068	794	6170	929	1166	1030	1102	1144	1254
293	293	455	455	555	505	676	6220	795	7100	930	1029	1031	1172	1145	1255
294	294	456	456	556	506	678	1143	796	611	931	1029	1032	1170	1146	1256
295	295	457	457	557	534	679	552	797	7090	932	1086	1033	1168	1147	1240
296	296	459	459	559	159	682	552	798	161	933	1025	1034	1161	1148	1276
301	301	461	461	560	548	683	1066	801	201	934	1026	1035	1179	1149	1277
303	303	464	464	561	162	684	1131	804	595	935	1269	1036	1144	1150	1217
311	311	466	466	562	524	685	584	807	7080	936	1270	1037	1150	1151	1014
315	315	468	468	563	501	686	1052	808	7110	937	1082	1038	1121	1152	1259
316	316	469	469	564	545	687	602	810	6950	938	1051	1039	1133	1153	1260
318	318	470	470	565	178	688	572	811	6950	940	1071	1040	1112	1156	1268
320	320	471	471	566	517	689	1001	812	6950	941	1085	1041	1177	1163	1273
325	325	472	472	567	158	690	7580	813	6950	942	608	1042	1158	1166	1171
326	326	473	473	568	616	691	530	814	7380	944	1067	1043	1020	1167	1305
328	328	474	474	569	163	693	7280	815	7420	947	1100	1044	1021	1169	1193
329	329	475	475	570	184	694	1049	816	554	951	1078	1045	1199	1171	1258
330	330	476	476	574	528	697	7190	817	529	954	1137	1046	1220	1173	1263
332	332	477	477	576	593	698	6700	819	7120	955	1090	1047	1152	1176	1315
334	334	479	579	578	527	701	1046	820	7070	956	1097	1048	1182	1177	1280
335	335	481	481	583	195	704	511	824	174	957	1022	1049	1183	1180	1321
336	336	483	165	584	565	708	7640	825	7440	958	1091	1051	1175	1185	1290
337	337	484	484	585	579	709	1007	831	603	959	1148	1052	1180	1187	1304
338	338	485	175	587	196	710	1154	832	604	960	1163	1053	1096	1192	1288
342	342	486	486	588	160	712	7490	834	6440	962	1139	1054	1184	1195	1279
344	344	488	488	590	194	715	570	838	568	963	1081	1055	1197	1196	1297
345	345	489	489	592	557	716	614	839	596	964	1110	1057	1196	1204	1278
346	346	490	490	593	193	717	157	840	6770	965	1093	1058	1181	1205	1275
352	352	491	491	596	7180	718	535	841	7600	966	1098	1059	1188	1206	1146
353	353	492	492	597	564	720	608	842	7650	967	1096	1060	1189	1207	1147
357	357	493	493	598	574	721	531	844	498	968	1128	1061	1190	1208	1286
360	360	494	494	599	7450	722	7400	845	532	969	1132	1062	1191	1225	1327
362	362	495	495	600	7470	723	200	846	541	970	1129	1063	1192	1234	1299
365	365	496	496	602	6800	724	176	848	606	971	1109	1064	1239	1235	1295
366	366	499	499	603	197	725	555	849	6890	972	1138	1066	1208	1236	1296
369	369	500	500	604	6220	728	6510	850	7140	973	1039	1067	1267	1237	1181
373	373	501	170	605	539	729	575	851	7550	974	1114	1070	1209	1240	1307
375	375	503	503	608	6360	730	598	853	7150	975	1155	1073	1316	1241	1309
383	383	506	190	617	6290	731	183	854	6400	976	1153	1074	1317	1243	1308
386	386	507	180	618	601	732	7350	855	7170	977	1204	1075	1318	1244	
387	387	508	508	619	7500	733	615	857	1010	978	1068	1076	1266		
394	394	512	512	622	7560	734	1004	858	188	979	1186	1077	1266		
395	395	513	513	623	563	735	7480	859	188	982	1212	1080	1213		
396	396	514	514	625	7060	736	7730	860	189	983	1302	1081	1214		



Measuring the left and the right channel separately can be done by using an oscilloscope and a test record with sine waves for left and right channels.

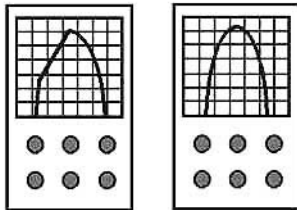
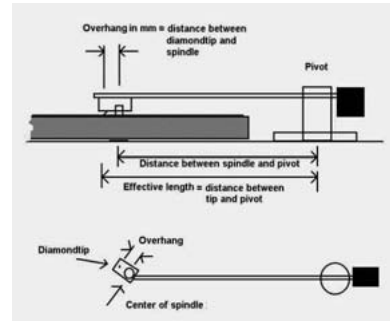
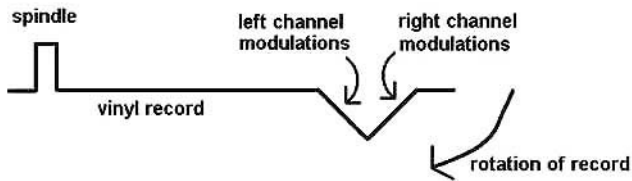
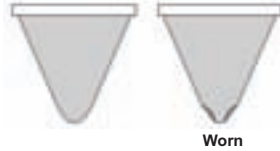

The sinus on the left is not a sinus but shows the distortion which is the result of ill contact between tip and groove wall. On the right the oscillograph shows that the contact is correct. Both left and right signals should show a perfect sinus when highly modulated grooves on the test record are played.

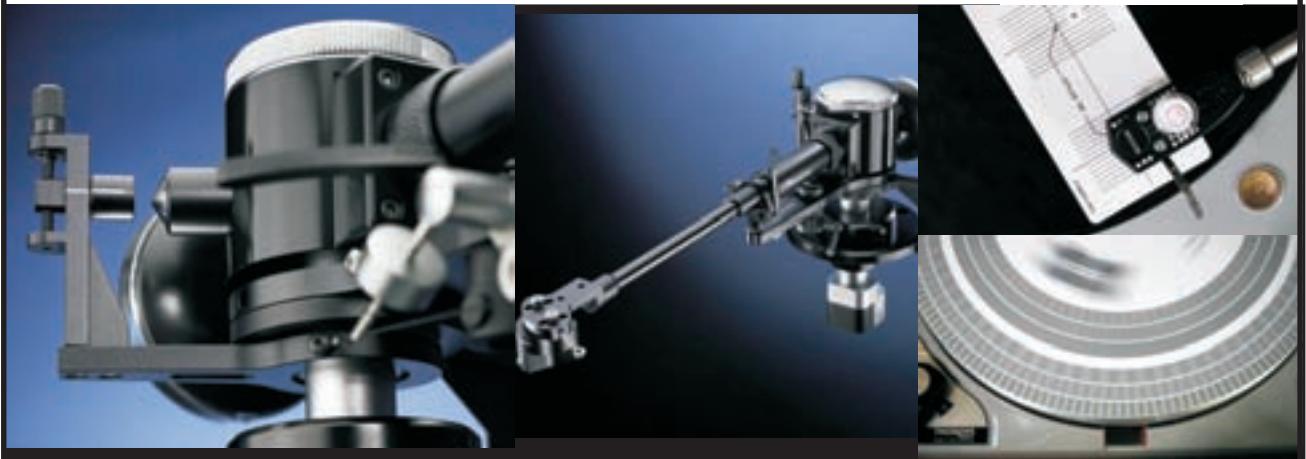
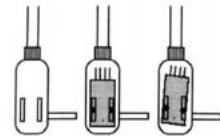
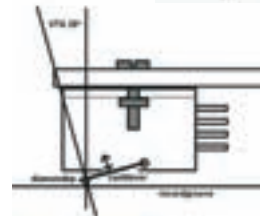
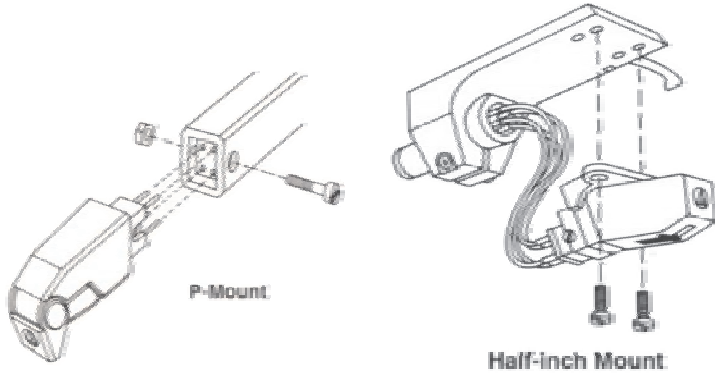
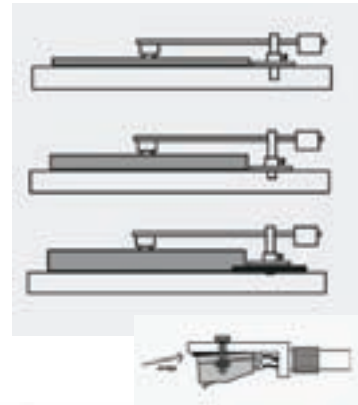

CARTRIDGE ALIGNMENT PROTRACTOR

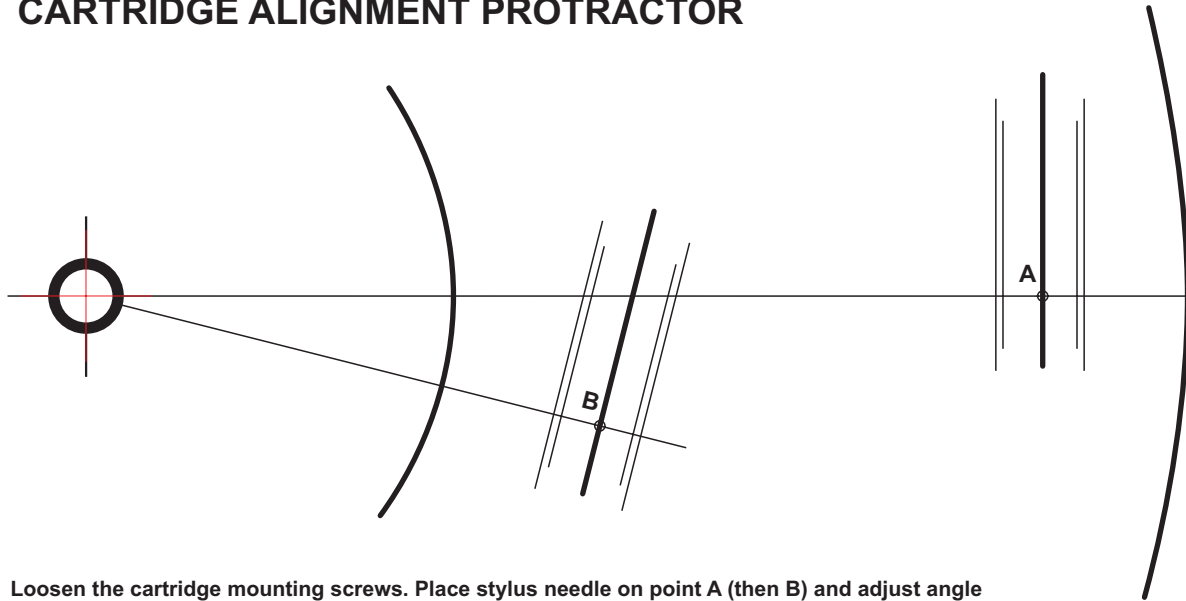

Loosen the cartridge mounting screws. Place stylus needle on point A (then B) and adjust angle to best align up with both points A & B. Adjust overhang (Forward/Back movement) if any error.

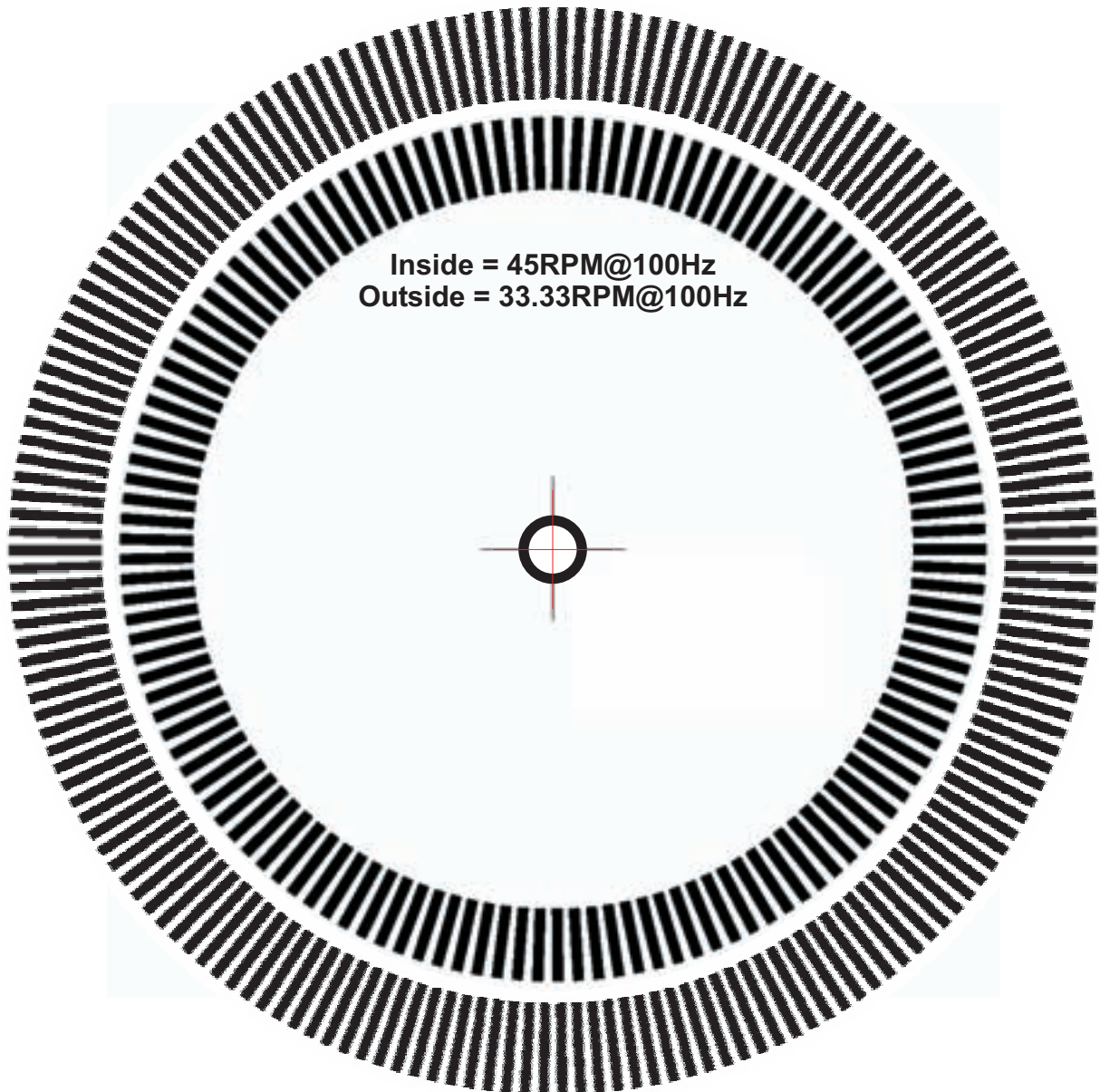



MUSIC



STANFIELD

2008 Stylus Catalogue

Wholesale Distribution:

WES Components Aust-Asia

02-9797-9866

sales@wes.net.au