



Door Entry Security

2 Wire Audio

AUDIO-ONLY INTERCOM

DOOR ANSWERING SYSTEM

A basic system comprises a H2-595A Door station with call button and 2 Way audio connections via the H2 2-Wire system to a H2-DJ4. Power is supplied by use of a 24Vdc power pack and a DPS power injector. An EL971 Door Catch can also be used for door entry. All items are sold separately.

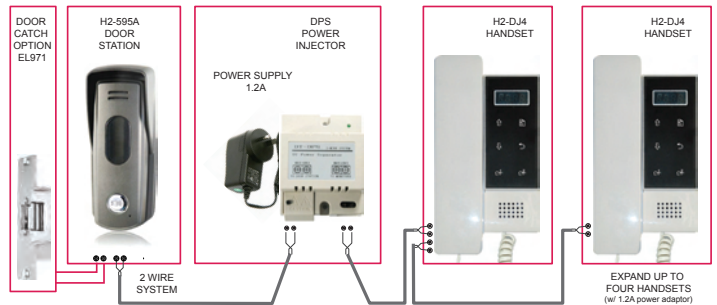

LOOK-C

Door Intercom Systems

EXPANDABLE SYSTEM

The real value of this system is its expandability into an advanced programmable system of multiple door entry and monitors by use of additional H2 accessories.

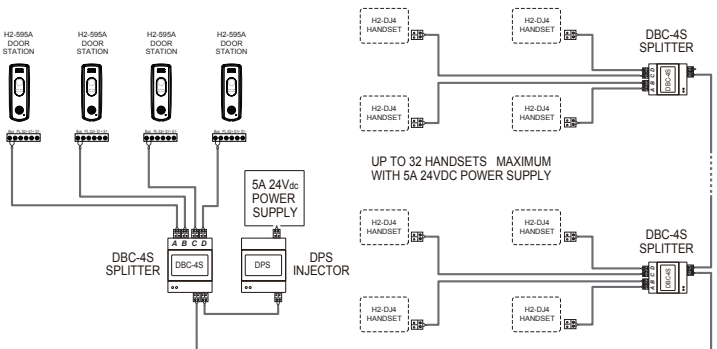

See manuals for details

<http://data.wesccomponents.com/lookc/>

AUDIO-ONLY DOOR STATION

- Audio only, no camera.
- 2 Wire compatible.
- Door bell call button.
- Microphone and speaker to converse.
- LED indicators Talk/Unlock.
- Programmable unit ID Code.
- Door strike output optional.
- Metal construction IP55.
- 24Vdc 60/200mA
- 137x49x28mm



Code
H2-595A

AUDIO-ONLY HANDSET

- Handset audio only phone intercom & door answer
- Touch sensor button modern style with LED display
- Programmable ring tones for intercom or door station
- 2x door open buttons programmable from 4 doors
- Compatible with all H2 outdoor & indoor stations
- 24V (25mA/110mA)
- 187x97x33mm



Code
H2-DJ4

AUDIO-ONLY POWER REQUIRED

INJECTOR - DIN MOUNT

Inserts power from a 24V source and inserts it into the twisted pair line.

Code
DPS



POWER PACK 24VDC 6A

As required to power the DPS injector.

Code
SMP24V6A-25P



HANDSET SPLITTER

FOUR WAY BRANCH

Splits 2-Wire system into Four audio output for handsets. Extra DBC4S can be added to the master line if required.

or
Four video inputs for combining door cameras with door control. DIN Mount.

Code
DBC-4S



RAIN HOOD

SUIT H2-595A

Outdoor weather resistant rain shield zinc alloy.

Code
RH595



ANGLE BRACKET

SUIT H2-595A

Tilt door station to the left or right 30°. Outdoor weather resistant zinc alloy.

Code
AB595



DOOR STRIKE

FAIL SECURE

Remote entrance Door catch release. Requires a trigger of 12Vdc 500mA to enable a door to be pushed open. Mounts into the frame, replacing the door catch. 150mm Mortise Mount.

Code
EL971





Look-C Door Intercom

□ Door Entry Security

□ 2 Wire Video

2 WIRE DOOR VIDEO INTERCOM

Latest in door video innovation. Intelligent twin wire system which allows for a quick and economical installation. System setup is easy via the comprehensive yet simple menu system. Modern design and style to suit all modern decors.

- No polarity, twisted pair, easy wire solution. Use Cat5 or twin core cable
- One common power supply to door stations and monitors
- Supports 1 to 4 monitors connected in a daisy chain (loop in, loop out) for easy installation.
- Can be star wired by the addition of a 4 way splitter (DBC-4S)
- Supports 1 door station or can be expanded to support up to 4 door stations by adding a splitter (DBC-4S)
- Door stations can open door latches (EL971 Optional)
- Power supply and injector built into one DIN mountable module for ease of mounting and wiring

Ordering is simple, order the door station, monitor of your choice with the PC6 package and as many additional monitors you require, up to 4. If more than 4 monitors are required, not a problem, the system can be expanded up to 16 monitors however a higher current power supply and one 4 way splitter for each set of 4 monitors is required. Please see our website for more information. data.wescomponents.com/lookc/

Basic wiring mode for loop in / out (daisy chain) wiring

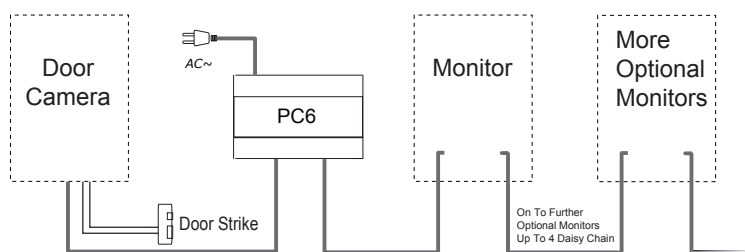

Basic wiring for star configuration

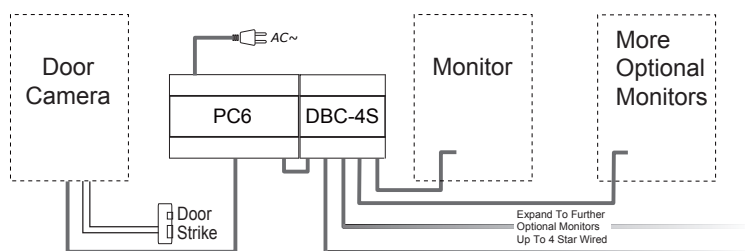

LOOK-C Door Intercom Systems

2-WIRE VIDEO SYSTEM



If more than 4 monitors are required, not a problem, the system can be expanded up to 16 monitors however a higher current power supply and one 4 way splitter (DBC-4S) for each set of 4 monitors is required. Please see our website for more information.

<http://data.wescomponents.com/lookc/>

DOOR ENTRY CAMERA

IP45 OUTDOOR

Sharp brand CCD in a heavy duty door station with hood.
 Attractive and stylish zinc-alloy housing.
 Camera's viewing angle is adjustable.
 LED lit name plate display
 IP45 weather rating.
 IR illumination for 0 lux night vision
 176x90x23mm. requires cable.

Code
 H291RH

Sold separately.
 Requires cable
 and monitors.



See our website for wiring details.
<http://data.wescomponents.com/lookc/>

DUPLEX CAMERA

ONE CAMERA TO TWO DWELLINGS

One monitor to two dwellings (duplex).
 Sharp brand CCD in a heavy duty door station.
 Two call buttons with illuminated labels.
 IP45 weather rating.
 IR illuminated for 0 lux night vision.
 176x90x23mm.
 Requires cable.

Code
 H292RH

Sold separately.
 Requires cable
 and monitors.



See our website for wiring details.
<http://data.wescomponents.com/lookc/>



7" LCD COLOUR VIDEO DOOR MONITOR - TOUCH SCREEN H2

HIGH-RESOLUTION MONITOR WITH VISITOR RECORDING FEATURE

7" Colour Digital TFT Monitor with touch screen and SD card recording. Low-profile minimalist style in ultra-modern contemporary design. No protruding buttons! Super sleek touch control. Back illuminated. Full colour High resolution TFT LCD 16:9 wide screen 800x480px. Easy Icon GUI menu control for advanced feature set system.

- Digital TFT Screen
- Touch sensor button
- 118Mb Inner flash memory
- Max. 16Gb SD card picture memory
- Home away auto memory
- 1/4/8 auto photo shooting
- Digital Photo Frame Playback
- Power supply: 24Vdc 400mA
- LCD 840x480px wide-screen
- 125x225x28mm



PC6 Power Supply includes 24Vdc and Injector. Accepts one or two door cameras, sold separately. Expansion accessories available. See H2 system.

Record	Details	Code
Yes	7" Monitor with PC6 Power supply	H2-27SDD
Yes	7" Monitor only	A2-27SDD
No	7" Monitor with PC6 Power supply	H2-27TD
No	7" Monitor only	A2-27TD

RECORDS VISITORS 10s. Video	EXPAND MEMORY SD Card	PHOTO FRAME CYCLE	
TOUCH SCREEN MENU	7" LCD HIGH-RES SCREEN	KIT INCLUDES CAMERA, MONITOR, & POWER SUPPLY REQUIRES CABLE	

4" LCD COLOUR VIDEO DOOR INTERCOM H2

LOOK-C LOW-PROFILE WIDE-SCREEN

- High quality 4" TFT LCD Digital Screen
- Colour icon and text menu display OSD
- Plastic housing with aluminium front panel
- Streamlined & thin design. 23mm thin.
- Assorted melody chimes (x12) programmable
- Compatible with all H2 outdoor & Indoor stations
- Power Supply 24Vdc (Optional)
- Standby 15mA; Working status 210mA (on)
- 4" Digital 4:3 TFT 320*240 pixels
- Wiring: 2-wire (no polarity) up to 100M
- 200x135x23mm

Details	Code
Monitor w/ PC6	H2-254
Monitor Only	A2-254

Note: H2-254 w/ PC6 refers to the 1.5A power supply and injector required one per system (depending on total power requirements: See DPS option).

LOOK-C
Door Intercom Systems



<http://data.wescomponents.com/look/>

3.5" LCD COLOUR VIDEO DOOR INTERCOM H2

2-WIRE STATION VERTICAL DESIGN

3.5" Colour Digital TFT Screen 320x240px. Compact and slim design to suit any decor. White plastic casing with silver surround. Modern vertical style, brushed aluminium trim. Kit Includes monitor and PC6 powerpack. All parts available separately for expansion.

- Entrance Monitoring view
- Auto On with Call button
- Converse with entrance
- Door open control with
- Optional Door Catch
- up to two locks per station
- Intercom between monitors
- Monitors naming function
- GUI Menu system
- Selectable door chime
- Adjustable picture
- Light On (Req. DCU)
- Expand up to 16 units
- 220x110x20mm
- 210mA (on)

Details	Code
Monitor w/ PC6	H2-16D
Monitor Only	A2-16D

Note: H216D w/ PC6 refers to the 1.5A power supply and injector required one per system (depending on total power requirements: See DPS option).



<http://data.wescomponents.com/look/>

HANDSET AUDIO-ONLY

- Handset audio only phone intercom & door answer
- Touch sensor button modern style with LED display
- Programmable ring tones for intercom or door station
- 2x door open buttons programmable from 4 doors
- Compatible with all H2 outdoor & Indoor stations
- 187x97x33mm 24V (25mA/110mA) 2 Wire system

Code
H2-DJ4

<http://data.wescomponents.com/look/>





Look-C Door Intercom

PC6 POWER SUPPLY WITH INJECTOR

Suitable only for the 2wire (H2) systems.
Din Rail mount. 140x90x60mm
100 – 240v Ac input

Code
PC6

2-WIRE
VIDEO
SYSTEM



POWER INJECTOR DPS

Used when a higher current power supply is required. The DPS injects power into the 2 wire system to allow all of the door stations and monitors to operate from one power source.
Din rail mount, or wall mount.

Injector only, power supply required.
See our website for wiring details.

Code
DPS

Injector Only.
Requires Power Supply.
24Vdc.



SPLITTER 4 WAY DBC-4S

Required when additional door stations (max 4) or additional monitors, (Max 16) are required.
One DBC-4S is required per 4 monitors.

Code
DBC-4S

See our website for wiring details.

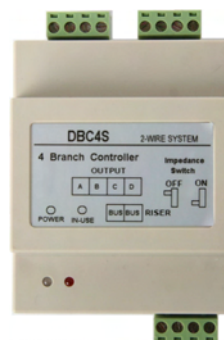

CCTV CONTROL UNIT H2

ANALOGUE VIDEO WITH LOCK CONTROL

Allows the 2 wire system to be expanded to include up to 2 Analogue cameras. Incorporates call button input and control output for light or door opener.

Code
DCU

See our website for wiring details.



POWER SUPPLY OPTIONS FOR DPS

REQUIRES DPS H2 INJECTOR

2-Wire system is designed to be economical in power. For a single monitor and camera combination the 1A power supply PS6 will suffice. However, it is recommended that if the system is expanded, that using the DBC4 injector and then connect a high current supply. 24V @ 6 Amps. 170x60x40mm

Code
SMP24V6A-25P



DOOR STRIKE

FAIL SECURE

Remote entrance Door catch release. Compatible with our door intercoms and other units. Requires a trigger of 12Vdc 500mA to enable a door to be pushed open. Mounts into the frame, replacing the door catch. Power supply NOT included. 150mm Mortise Mount.

Code
EL971

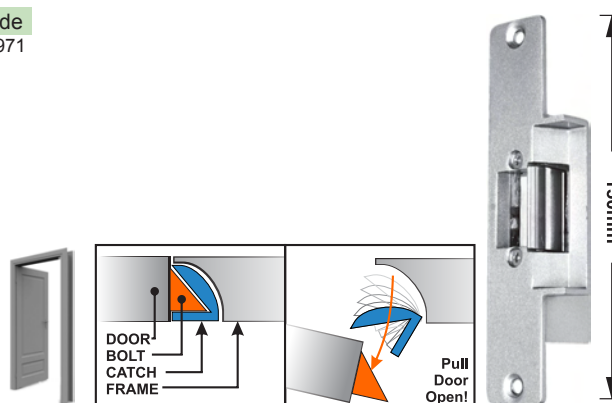

TWISTED PAIR DROP CABLE

High grade, high current, low loss, low capacitance. Extends distance of standard CAT5 runs by twice as far. Twisted pair in black PVC Jacket, ideal for running through walls and areas which are damp and prone to water penetration or applications where a better quality cable is required.
8mm Outer sheath 1mm thick "Drop Cable" Jacket.
3mm with 48 strands x 0.2mm x 2 core.

Length Code
100M CAB4822



From	CAT5	CAB4822	DPS	CAT5	CAB4822	To
Camera	40M	80M	PC6	50M	100M	Monitor



□ Door Entry Security

□ 4 Wire Video

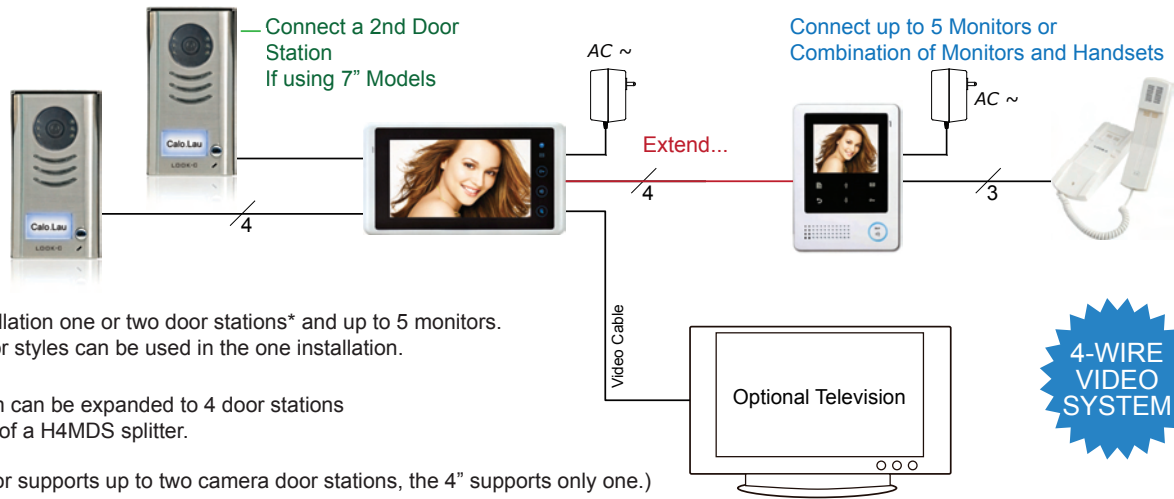

Basic installation one or two door stations* and up to 5 monitors. Any monitor styles can be used in the one installation.

The system can be expanded to 4 door stations by the use of a H4MDS splitter.

(* 7" monitor supports up to two camera door stations, the 4" supports only one.)

**Example only. Other models may differ in connection. See the units supplied manual.*

4 WIRE DOOR VIDEO INTERCOM SYSTEM

An easy to install digital colour video intercom system. Supplied as individual pieces so as to design your custom system that is expandable with additional items. Suitable for DIY home or office video security solutions. Add a door sentry today for low cost and peace of mind.

- 4 wires (polarized wiring) for a simple one cable setup.
- Cable is not supplied. Order to length required.
- Use common twisted pair (eg. CAT5) up to 100M.
- For long lengths or noisy environments, upgrade cables; use dual coax for audio & video & Fig.8 cable for power.
- Connect up to 5 Monitors or
- Combination of Monitors and Handsets
- System is expandable from 1 to 4 outdoor stations or standard CCTV cameras with optional H4-MDS switcher.
- H424 & H427 are compatible on the 4 wire system however not all features are shared (eg. memory).

H4MDS 4-WAY CAMERA SWITCH & DOORWAY CONTROLLER
For more cameras (up to 4) the additional H4MDS is required. H4MDS is also compatible with standard CCTV type cameras.

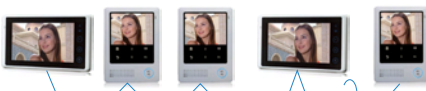

4 CORE CABLE

TESTED WITH CAT5 CABLE FOR UP TO 100 METRES FOR LONGER LENGTHS OR NOISY ENVIRONMENTS, SHIELDED CABLE IS AVAILABLE. PLEASE ENQUIRE



DOOR CAMERA COMPACT

- Zinc alloy housing attractive design
- Outstanding audio performance
- Wide angle colour CCD Camera
- High resolution Sony ACS 4T DSP
- High white led light for night view
- IP55 protection rated outdoor
- Compact 137x49x28mm
- Available with/without rain cover

NO RAIN HOOD

Code
H4-595

WITH RAIN HOOD

Code
H4-595RH

ANGLE BRACKET

Tilts station left or right 30°
Code
AB595



TAMPER PROOF CAMERA

IP45 OUTDOOR

Sharp Brand Colour CCD Camera in a heavy-duty outdoor station with rainy cover. Attractive and stylish zinc-alloy housing. Strong waterproof & tamper-proof design. Camera's viewing angle is adjustable. Name plate display with white LED lit. IR Illumination for 0 Lux night vision. 176x90x23mm. Requires cables.

Code
H491RH

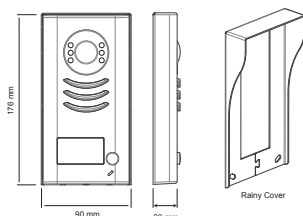

IP45 CAMERA DUPLEX

SINGLE CAMERA TO TWO DWELLINGS

IP45 Weather resistant attractive Zinc alloy brushed aluminium styled door station with rain hood. Flush mount. Infrared illuminated. Dual name plate illuminated. Two button door bell push. 176x90x23mm

Code
H4-92RH



LOOK-C
Door Intercom Systems

<http://data.wescomponents.com/look/>



Look-C Door Intercom

7" LCD COLOUR VIDEO DOOR INTERCOM H427DT

LOOK-C LOW-PROFILE WIDE-SCREEN

Low-profile 23mm thick, 240x145mm monitor with frame in 2 colours. View full colour high resolution 7" TFT-LCD Screen 1440x234 pixels. Answer 1 or 2 doors via the video intercom (*up to 4 units w/ H4-MDS) Push-button door opening function (Requires optional door latch) Expandable system to more H427 & H424 monitors & door cameras. Simple 4-wire system (Cable Not Included) up to 100 Metres of CAT5. Attractive & stylish wall mount unit, easy to install, setup and operate. Includes mains power adaptor for monitor (and one or two door stations). SD Card memory model is available optionally, see SDD version below.

Description	Code
7" Monitor	H427DT

This 7" monitor will support one or two door stations. For more camera or door station inputs, see H4QSW Quad Screen or H4MDS Camera Splitter.



7" WITH OPTIONAL RECORDING FEATURE H4

128MB VIDEO MEMORY INBUILT - MicroSD EXPANDABLE

Automatic function for recording each door button press, ready for instant playback when you get home, to see who came while you were out! This unit stores 3x 10 second video captures plus a *SD micro expansion slot to extend this. Doubles as a Photo Frame SD memory image player too! *SD micro card up to 16GB is extra.

Description	Code
7" Monitor SD Memory	H427SDD
Monitor Wiring Splitter	H4BDU
Door Camera Splitter	H4MDS
Quad Screen	H4QSW
Remote Light Switch	H4RLC

Expansion options. See next page for details.



- TOUCH SCREEN OSD MENU**
- RECORDS 10 SECONDS ON EACH DOORBELL PRESS**
- BUILT-IN MEMORY PLUS SD-MICRO CARD SLOT MEMORY (Optional)**
- SD SLIDE-SHOW FEATURE CYCLES FAVOURITE PHOTOS**
- INTERCOMM (AUDIO ONLY) TALK BETWEEN BASE STATIONS**

4" LCD COLOUR VIDEO DOOR INTERCOM H4

High resolution 4" TFT Digital LCD Screen in a wall-mount enclosure. Large illuminated talk button. Optional "unlock" door latch available. 210x160x25mm Low profile, attractive wall mount modern design. Intercom between additional monitors and/or handsets. Expands to up to 5 monitors or combinations of monitors and handsets. Easy to install 4 Core cable solution. Order cable separately. Requires H4 system door station camera - Sold Separately. Includes mains power adaptor for monitor (also runs one door station). Optional Memory Module stores images captured during door bell press.

Description	Code
4" Monitor	H424
Memory Module	H4MEM

H4MEM is an extra module for video storage that captures visitor images while you are not at home.



TOUCH BUTTON

Advanced Structure - With Additional Parts

4-WIRE CONNECTION
Using the H424 (Main Distribution Switch) unit to extend 4 door stations or CCTV cameras.

PLC unit connection
Using the H424 (Main Distribution Switch) unit to control 4 door stations or CCTV cameras.

OPTIONAL MEMORY UPGRADE
H4MEM

OPTIONAL DOOR STRIKE
EL971

H484

H491RH





HANDSET ONLY

EXPANSION OPTION WITHOUT MONITOR

Expands an existing intercom door answering system. Connects with any Look-C 4-Wire monitor units. Add-on to the monitor kit for use as an extra station for talking to other handsets, monitors or cameras. Buttons for answering/calling and door release control. Attractive white finish suits any decor. Wall mountable. System can include up to FIVE monitors and/or handsets. Three core cable for connecting to the system is required. No additional power is required. Suit 4-Wire system only.



Code
H4-72

DOOR STRIKE

FAIL SECURE

Remote entrance Door catch release. Compatible with our door intercoms and other units. Requires a trigger of 12Vdc 500mA to enable a door to be pushed open. Mounts into the frame, replacing the door catch. Power supply NOT included.

Code
EL971

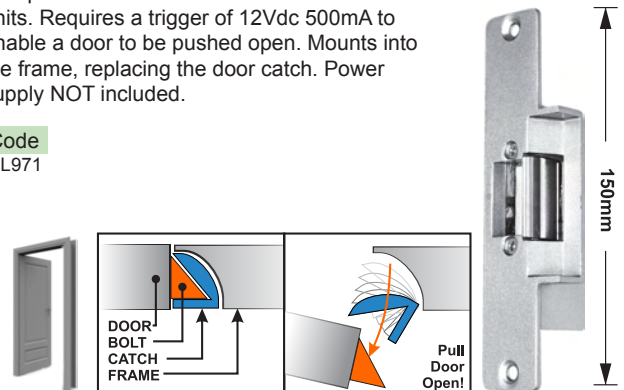

MULTIPLE CAMERA AUTO-SWITCH

UP TO 4 DOOR CAMERAS

Compatible with "Cycle View". Extends the 4-Wire system to 4 cameras in total. Door strike control compatible. Works with standard video sources too! Connect cameras, CCTV, etc.



Code
H4MDS

4-WAY MONITOR WIRING SPLITTER

AND SIGNAL BOOSTER

4-Wire monitors are usually wired in a daisy chain fashion. If star type branch wiring is required then use this splitter for connecting up to 4 monitors, or 3 monitors and even more Splitters.



Code
H4BDU



<http://data.wescomponents.com/lookc/>

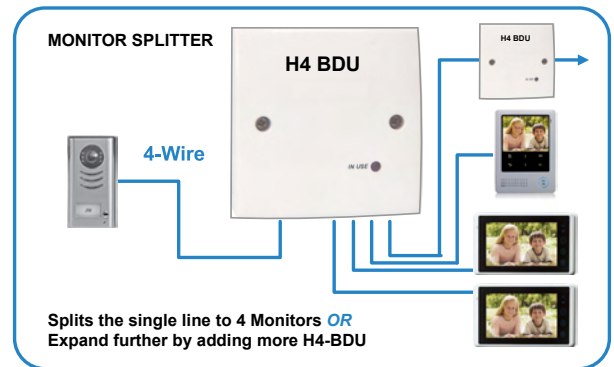

<http://data.wescomponents.com/lookc/>

QUAD SCREEN & CAMERA MODULE ADD-ON

ALLOWS TO VIEW 4 CAMERAS ON ONE 7" SCREEN

Enables combining 4 door cameras or normal composite cameras into the four wire system as well as also viewing all four cameras on a single screen by way of quad split screen. Quad or single viewing is switched at monitor. Compatible with H427DT/SDD 7" units only.



Code
H4QSW



<http://data.wescomponents.com/lookc/>

REMOTE SWITCH

LOW VOLTAGE LIGHT SWITCH

Enables control of a light or second door strike. Single pole, single throw, low voltage relay output.

Code
H4RLC

Connects inline with the 4-Wire system.

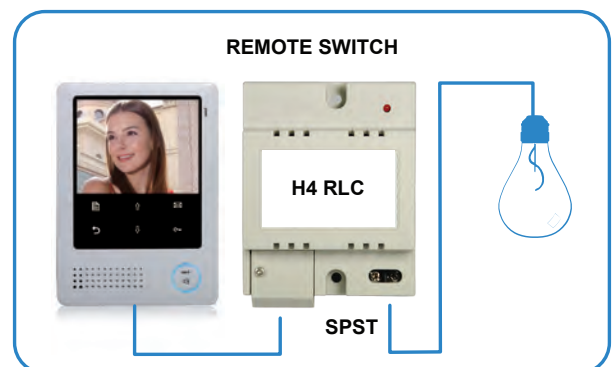

<http://data.wescomponents.com/lookc/>



Look-C Door Intercom

Door Entry Security

4 Wire B&W

B&W 4" CRT VIDEO DOOR PHONE HANDS-FREE

MONITOR & CAMERA KITS - H4 COMPATIBLE

Excellent economical solution with Low-profile side projection 4" B&W picture tube and IR Illuminated for bright and clear night viewing. Convenient hands-free view and hear operation. Auto-On screen and listen on door-bell press. Push-button to talk to your visitor before entry and allow them in with the optional EL971 Electronic release door catch actuator control. System is easily expandable with the addition of extra monitors (5) and/or extra door cameras (4). Intercom feature allows for communication between additional monitors in different rooms of the house. You can also integrate the B&W monitors in with Look-C range of Colour H4 System if desired (Colour door camera required for colour system)

REQUIRES 4-CORE TWISTED PAIR CABLE TO LENGTH BLACK & WHITE KITS

Kit Includes one 4" B&W Monitor & one Door camera. Requires connection cable. Monitor size 220x190x55mm
ADD MORE CAMERAS(2)* & MONITORS(5)
 Up to 5 base monitors can all share on the one system. Connect two cameras and door strikes to one system. See and control extra doors with a CSM expansion module. For 2 to 4 cameras added require H4-MDS Switcher to suit.

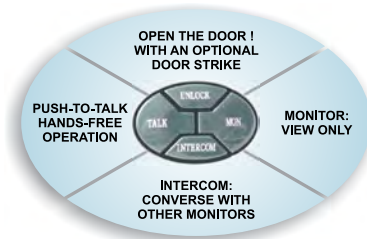

SUPPLIED WITH H4-87 SURFACE MOUNT DOOR STATION 100x130x40mm



REQUIRES 4 CORE CABLE TO LENGTH....

Description	Code
Base unit & H4-87 Surface Mount Camera	BWS68SU

EXPANDABLE B&W SYSTEM ITEMS

Description	Code
Monitor Only	BWM68
Handset Audio Only (No Screen)	H4-72
Surface Mount Camera Only	BWC580
Duplex Dual System Camera	BWC586
Door Camera Splitter	H4MDS
Door Strike	EL971
Weather Shield for cameras	RH584



95x150x15/40mm
Flush Mount
H4-84



Rain Hood
Flush or Surface
RH584



BWC586



Handset Only
(No Video)
VT672

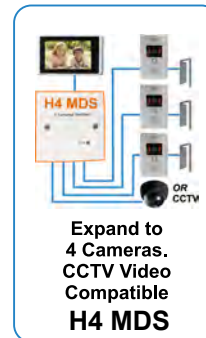

Expand to 4 Cameras.
CCTV Video Compatible
H4 MDS

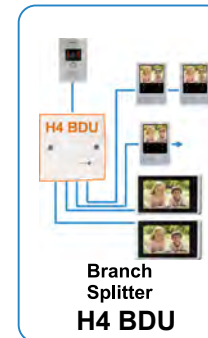

Branch Splitter
H4 BDU

REQUIRES CABLE

Cable is NOT included in any of the Look-C kits. 4 Core Low voltage "Bell wire" is required. eg. Telephone, CAT5 or security cable, etc. For runs up to 20M we recommend SEC414 (ACA Approved). For longer runs, CAT5 twisted pair type cable is quite suitable up to 100M. For electronically noisy environments or to ensure maximum picture quality we have available shielded coax cable with control wires.

Length	Description	Colour	Code
100M	Coax + 5 Control Wires	Cream	SEC7505
305M	Coax + 5 Control Wires	Cream	SEC17505
100M	8 Core Category-5e Cable	Blue	CNC5100BU
50M	8 Core Category-5e Cable	Blue	CL161BU
25M	8 Core Category-5e Cable	Blue	CL158BU



CAT5 cable is available in Blue, Yellow, Grey, Red, Green and Pink. Other lengths are also available. See Cable Section for CAT5 Cable.



OPTIONAL DOOR STRIKE
REQUIRES 12V 500mA
Power Pack Not Inc.

- **DOOR STRIKE EL971**
 - Door-Strike Requires 12Vdc/500mA source, local or remote
- | Code |
|-------|
| EL971 |

