

# TV Repair Parts



■ <b>Television Parts</b>	2
■ Cabinet Parts.....	7
■ CRT Parts.....	2
■ Flyback Transformers.....	10
■ LCD TV Parts.....	5
■ LOPT High Voltage Leads.....	6
■ Power Supply Parts.....	7
■ Projector Parts.....	4
■ Repair Assistance & Tools.....	8
■ Triplers.....	6
■ Triplers.....	17
■ TV Wall Brackets.....	18



## Television Parts CRT Parts

### HIGH VOLTAGE TV FOCUS RESISTORS

1 WATT, 10KV-DC, 7KV-ACrms  
Available in 150K, 220K, 270K,  
390K, 470K, 820K, 1M, 1.2M,  
1.5M, 2.2M, 3.3M, 4.7M, 5.1M,  
8.2M, 10M Order as follows:

Wattage + FCR + Value  
Eg. 150K would be  
ordered as 1FCR150K

Code\*  
1FCRxxx



### PHILIPS FOCUS POTENTIOMETERS

24 MegaOhms Suit Philips.  
Three solder terminals

Original Part No	Code	Cost
460-900-22	FCP24	\$7.86

Two contact  
"push-on" type

Code  
FCP23



### AC POWER SWITCH POTENTIOMETERS

#### SPDT PULL SWITCH

Potentiometer with pull  
out two pole switch. as  
used in older TV's.

Value	Type	Code
5K	Linear	VRS105
20K	Log	VRS120
50K	Linear	VRS150
100K	Log	VRS100

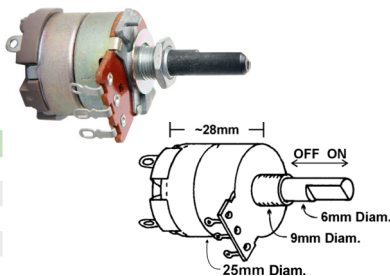

### HIGH VOLTAGE FOCUS POTS

Value	Code
10MΩ	FCP10M
15MΩ	FCP15M
22MΩ	FCP22M



### SANYO FOCUS CONTROLS

Original Part No	Code
RO116XR	FCP0116
R0128XR	FCP0128



### PHILIPS/KRIESLER CARBON TUNING TRACKS

Type	Code
3 way	CTR3
4 way	CTR4

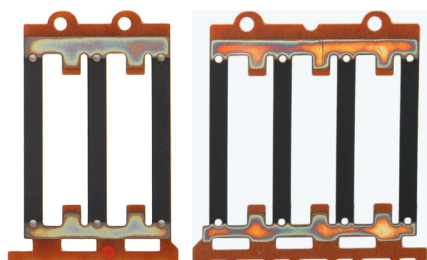

### LUMINANCE DELAY LINE FILTER

Suits many models.

Code  
DL401P



### ANTENNA INPUT PANELS

Both have isolating capacitors.

#### UHF/VHF TERMINAL

Code  
J517

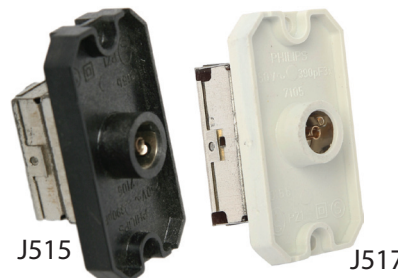

#### SINGLE TERMINAL

Code  
J515

### ANTENNA INPUT TERMINALS

#### METAL RF SOCKET

Code  
J500



#### PLASTIC RF SOCKET

Code  
J510

FOR OUR FULL RANGE OF PLUGS  
& SOCKETS FOR TV SEE SECTION  
CABLES & CONNECTORS

### PHILIPS DELAY LINE

Popular Delay Line as used in many TV's.

Equiv. Code  
DL701 SDL145

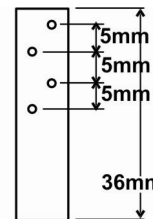
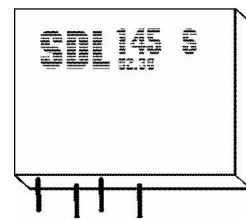
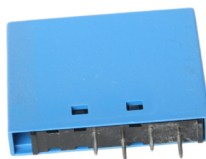

### UNIVERSAL 75Ω VHF-UHF TUNERS

#### RCA SOCKET 8 PIN

Height Socket Code  
38mm 10mm ECC55

#### RF SOCKET 8 PIN

Height Code  
34mm ECC50

#### RF SOCKET 8 PIN

Height Code  
38mm ECC48

#### RF SOCKET 8 PIN

Height Socket Code  
38mm 12mm ECC60

#### RF SOCKET 9 PIN\*\*

Original Part No Height Code  
TECC0985VA14B SAMSUNG 345-197-000-83 38mm ECC65

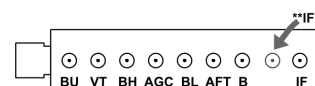
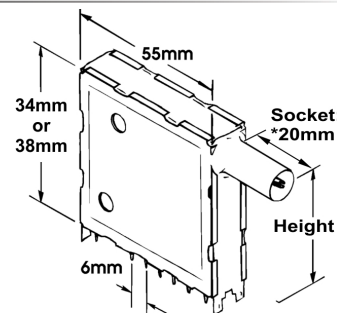



## PHILIPS PTC

Popular 3 pin degauss trigger.

Original Part No	Voltage	Current	Code
2322 662 96009,	265V	6mA	PTC10
2322 662 96016,			
2322 662 98009			
2322 662 96011,	265V	4mA	PTC14
2322 662 96211,			
2322 662 98011			
2322 662 96022,	265V	1mA	PTC1
2322 662 98018			
2322 662 96101	-	-	PTC12

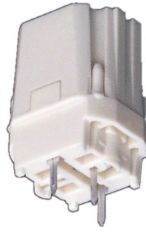

## PHILIPS PTC

4822 1164 0025, 4822 1164 0137,  
2322 6629 6022, 2322 6629 8018,  
96009, 96018, 96022, 96209,  
11164-0137, etc. 265V 1mA 3-Pin

Code  
PTC1

See Also ABOVE!  
Similar Style.

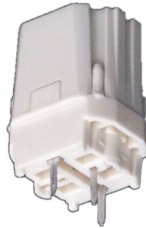

## PTC BLOCK

270V - 15mA

2 PIN

Code  
PTC22

3 PIN

Code  
PTC3

SHARP

Original Part No Code  
RMPTP0085CEZZ PTC85



BASE:  
~18x14mm

## PTC POSI-R

PTC Thermistor  
Nichicon Posi-R  
ZPB53-BL200C

Code  
PTC20



## SMPS START-UP PTC

Start-up PTC resistor  
Used in TV switchmode  
Samsung, LG, etc.  
P2462-J29, P190,  
1404-000182, etc.

Code  
PTC182



## 63V NON POLARISED (NP)

BI-POLAR TV Deflection Caps  
High Current. High-Frequency.  
For more capacitors, see section  
ELECTRONIC COMPONENTS

Value	Volts	Size	Code
2.2µF	63V	13x25	2.2BP63
3.3µF	63V	16x25	3.3BP63
4.7µF	63V	16x32	4.7BP63
6.8µF	63V	16x36	6.8BP63
10µF	63V	18x36	10BP63
15µF	63V	18x41	15BP63



## JVC SWITCH-MODE TRANSFORMER

Suit JVC 7255,  
7755 and others.

Code  
CE40511



## SHARP VARISTOR

Original Part No Code  
RH-XV0003CEZZ VX0010



## MAGNET CORE INDUCTOR

Horizontal-linearity coil  
Popular TV part used in  
many models including  
Akai, NEC, Tempest,  
Goldstar, etc.

14"TV 125µH(0.125mH)

Code  
L125

20"TV 102µH(0.102mH)

Code  
L102



## TEAC (Vestel) 11AK19 PARTS

Due to design problems with this chassis, HR Diemen has made  
some improved replacement coil transformers to suit. This applies  
chassis using the following EHT:

Original Part No Code  
3000-2055 EHT8339  
3000-2064 EHT8029



## TEAC SWITCH-MODE COIL

Chassis: 11AK19 (Vestel)  
East/West Coil

Original Part No Code  
4014100018, HR15028  
4014100020,  
30002026



## TEAC SWITCH-MODE COIL

Chassis: 11AK19 (Vestel)  
Correction Coil

Original Part No Code  
30002031, HR1843  
4015150018,  
3122 138 93871,  
AT4043-60

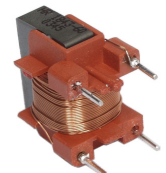

## TEAC SWITCH-MODE TX

Chassis: 11AK19 (Vestel)  
Power Transformer

Original Part No Code  
40326-92, HR9883  
10524150,  
30002080,  
4041800110





## 8 WAY TUNING BLOCK

28 Pin B20K  
23x76mm

Code  
VRB810

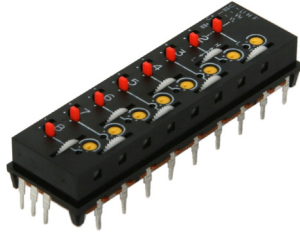

## SONY TV TUNING BLOCK

8 Way 29 Pin B100K  
21x82mm

Code  
VRB820

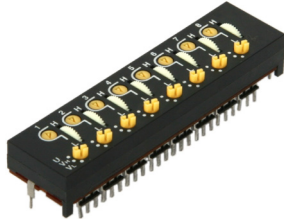

## 12 WAY TV TUNING BLOCKS

29 PIN B100K

Code  
VRB1220

40 PIN B100K

Code  
VRB1230

40 PIN B20K  
Vertical label

Code  
VRB1240

40 PIN B20K  
Horizontal label

Code  
VRB1250



23x108mm

## PICTURE SOCKET 8 PIN

8 Pins including focus.

Code  
CRT25

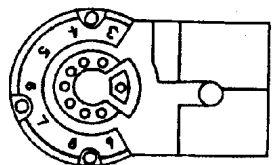
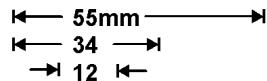

## PICTURE SOCKET 10 PIN

10 Pins including focus.

Code  
CRT12

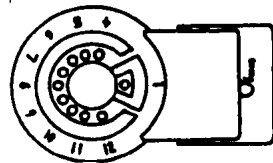
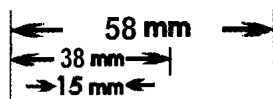

## DEFLECTION YOKES

Original part numbers and models are listed, however these Yokes will substitute many makes and models. "Spec." is the DC resistance measurement of the Vertical and Horizontal coils.

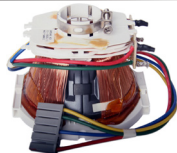

Description	Suit	Spec	Code
DIE1492HL or TCY120PPF (neck=30mm)	C38 Chassis P50F, P54S, CB336F/R, CTK115, 143, TE14F/R, 140E7A, 144E8A	H2Ω / V15.5Ω	DIE1492HL
ODYM1401 (neck=24mm)	TE14FC, RC, RM	H4Ω / V15Ω	ODYM1401
DSE1422FL (neck=24mm)	CB3351/A/FA/XU, CB3373Z1A, CTK118, 147, 1430, SP34RM, TV346, TVCR344, 346, NEC N3452.	H4Ω / V14.5Ω	DSE1422FL
ODYM2002 (neck=24mm)	TE20R/RM/RMT	H3Ω / V14.5Ω	ODYM2002
DIE1992GL (neck=29mm)	CB514H, TE20F, CTK202,	H2Ω / V14Ω	DIE1992GL

## Projector Parts

### REAR-PROJECTION TELEVISION & LCD/LDP PARTS

Samsung and other brands.  
More: Please Enquire!

Send your New Item  
Suggestions to  
Att: Product Manager.



## ETHYLENE GLYCOL COOLANT

OPTICAL GRADE PROJECTION TV  
HEAT TRANSFER FLUID 500mL

Suits Sony, Philips, etc.  
With application syringe.  
A Half Litre bottle of  
premium grade solution.

Code  
EGC500



## SAMSUNG COOLANT SEAL

48mmØ Spacer Cap  
Rubber Synthetic

Original Part No Code  
BP60-00050A SPC50



## OIL CLIP HOLDER PACK

### SAMSUNG REAR PROJECTION

Suit SP43J5HF  
Original AA91-00607A  
Part No  
Code AHP607



## SPONGE SPACER

### SAMSUNG DUST COVER

Suit SP42W5HP, SP43T5HP, SP43T6HFS, SP43T6HP  
Original AA60-00072B  
Part No  
Code SPC72

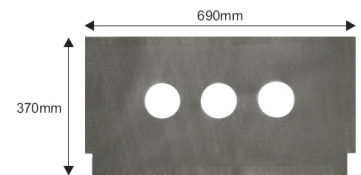





## □ LCD TV Parts

### LAMP BALLAST SAMSUNG

#### COMPLETE PCB - NO LAMP SUPPLIED

Suit	SP-46L5HX, &nbsp;SP-50L2HX
Original Part No	BP47-00008A
Equiv.	BP47-00002A
Spec	EUC 100W P/H00, 9137-007-04005
Code	BP47-08A



### LAMP LG

#### OEM LAMP & REFLECTOR

LDP & LCD Zeneth  
6912B-22002C 4930V00301  
DT-62SZ71DB RT-44SZ60DB

Code	RPL2002
------	---------



### LAMP SAMSUNG

#### LAMP ASSEMBLY OEM

Mercury Globe and Reflector assembly

Suit	SP-403JHP
Original Part No	AA47-10001B
Spec	160V 100W 1300mA
Code	AA47-01B



### LAMP LG

#### OEM LAMP & REFLECTOR

Rear projector TV  
LDP & LCD Zeneth  
6912B-22007B  
3141VSNH19C  
52SZ8R-TB

Code	RPL2007B
------	----------



### LAMP SAMSUNG

#### LAMP ASSEMBLY OEM

Globe & reflector assembly.

Suit	SP-46L5HX, 50L5HX, 61L5HX
Original Part No	BP96-00271
Spec	160V 100W 1300mA
Equiv.	BP96-00271B, C
Code	RPL271



### LG REAR-PROJECTOR LAMP

Original LG/Zenith DLP Lamp Replacement  
2000 Hours 100 Watts C UHP.  
Manufactured by Philips.

RT48SZ40RB  
RT52SZ30RB  
RT44SZ80LB

Brand	LG
Original Part No	6912V00006C 3110V00139A
Code	RPL0006C



### LAMP SONY

#### ORIGINAL SONY OEM

Original Sony OEM Part  
Complete Projector Lamp  
for a Sony Mobile Unit

Suit	VPL-ES2
Code	LMPE150

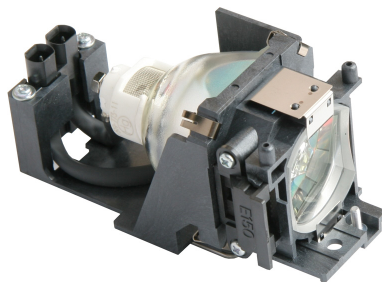

### LG REAR-PROJECTOR LAMP

Lamp only. High pressure M UHP  
120W/132W 1.0 PH Original LG  
part suits model 71SAID.  
Manufactured by Philips. High  
power with globe Air gap.

Brand	LG
Original Part No	6912B22009A
Code	6912B22009A



### LCD BACKLIGHT SOCKET

#### SHARP OEM

Inverter board to  
Back light tube  
connection socket  
Original sharp OEM

Code	QSOCA005
------	----------

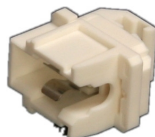

### LG REAR-PROJECTOR LAMP

Original LG Bulb Only For  
56DC1D-AB, Z62DC1D,  
Z52DC2D, Z56DC1D  
Rear projection TV.  
Manufactured by Philips.

Brand	LG
Original Part No	6912B22010A
Code	RPL2010A





## □ Triplers

### PHILIPS/ERO EHT TRIPLER

BG1895-641-444/LK/etc.  
TVK76, 13-2057, etc. Lead  
900mm Replacement type.  
DAICHI

Code  
TRP4006



### PHILIPS PYE KRIESLER

Original part # Code  
HR2176 EHT50

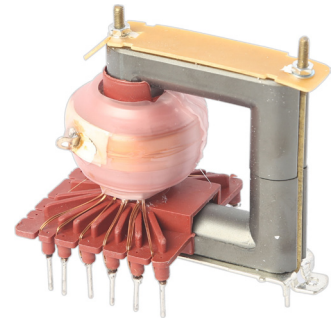

### AKAI KONWA TEAC GOLDSTAR SAMSUNG

Original part # Code  
CTM344 FC1434 EHT7729



### NORDMENDE SABA THOMPSON

11 pin type Nord Spectra Colour.

Original part # Code  
HR2080-00 EHT105  
FAT080-00  
11 PIN TYPE  
Nord SPECTRA  
COLOUR

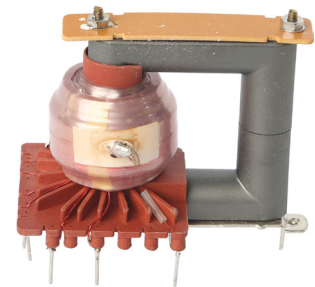

### AWA NEC DAEWOO TEMPEST TEAC

Original part # Code  
EHT315

AWA C3425 (C43M) NEC  
N3419 N3420 N3442 14"  
KFS60226B

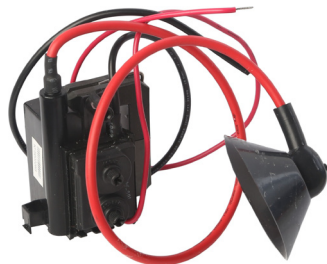

### MORE EHT & LOPT ARE AVAILABLE...

#### FULL LISTING AVAILABLE

Blaupunkt, Grundig, Rank-arena,  
Sanyo, Philips, etc.

Please contact us or visit:

[www.wescomponents.com/tv](http://www.wescomponents.com/tv)

Code Cost  
CAT-TV Free



## □ LOPT High Voltage Leads

### IBM 3179 HIGH VOLTAGE LEAD

Common fault in this  
model of IBM monitor.  
COD-011 with divider.  
IBM 3179, etc.

Original Part No 6405282, HR1697,  
HR 9R1, 1697  
Diemen 99 46 10  
Code HV3179  
Cost \$21.36

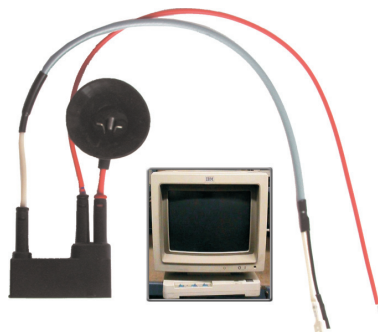

### HV LEAD GENERAL PURPOSE

As used in many Asian TVs and  
HR-Diemens LOPTs. Solid core  
tip for snap-fit or soldering.  
\*bol>SOLDER WIRE</bol>

Suit Length Code Cost  
HR-52 4136 COD-008  
50cm.  
HV1663  
\$8.27

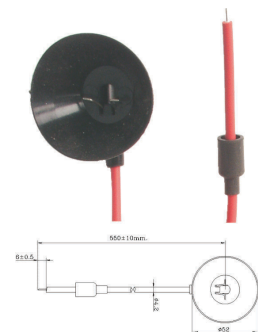

### HV LEAD SHIELDED

Popular Philips type.  
1M Shielded braid  
Snap fit LOPT end  
with 5mm tip

Code  
HV1681

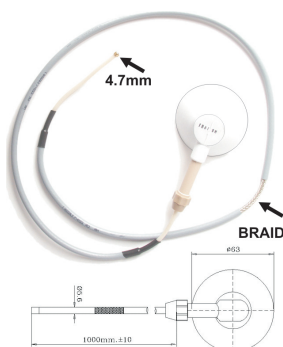

### MORE EHT & LOPT ARE AVAILABLE...

#### FULL LISTING AVAILABLE

Blaupunkt, Grundig, Rank-arena,  
Sanyo, Philips, etc.

Please contact us or visit:

[www.wescomponents.com/tv](http://www.wescomponents.com/tv)

Code Cost  
CAT-TV Free





## Power Supply Parts

### 12V TV POWER BLOCK

V Regulator for low voltage 10" TVs eg. Tempest TE10RM AKAI, PYE, Rover, etc.

**Code**

BL2710

BL2711

Suggest replacing C416

**Code**

100TKR63

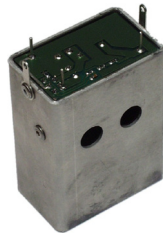

### SHARP TV X0308 POWER SUPPLY CHIP

#### Premature Failure Of Chip In Power Supply!

Changing values of the surrounding components for more reliable service. Kit includes instructions and all required parts.

**Code**

X0308-KIT

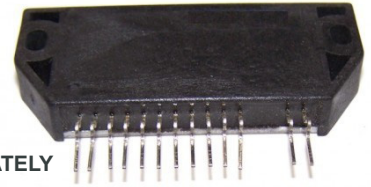

#### CHIP AVAILABLE SEPARATELY

Description	Code
Original	X0308-0
Substitute	X0308-CE

### SAMSUNG TV TDA3654 KIT

#### Premature Failure Of Chip In Power Supply!

Problem caused by excessive heat. This kit includes instructions, Chip & heatsink to fix.



Original Part No	Code
KIT-TVHSINK-1	TDA3654KIT

!! Requires Silicone Heat Compound - NOT Supplied !!

### PHILIPS SMPS REPAIR KIT

4822 310 20489 Power supply parts OEM, 27x OEM Parts including Surface mount components.

KIT SBC7020

Suit	Code
G110 Chassis	KIT489

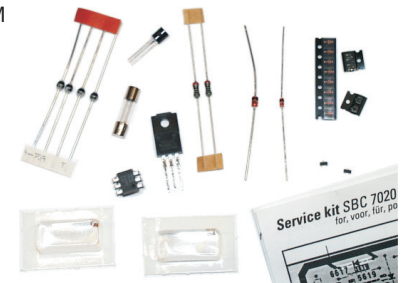

### SAMSUNG SMR40200C OR HIS0169B

#### Fault in Switch Mode Power Supply.

When replacing one, the other will blow! Kit CTV0034A-101297 Chassis P1B Pre 8/96

Original Part No	Suit	Code
KIT-TVSMPS-1	TV346,	SMR40200KIT
31122-0027-000,	486, 516,	
3H83-00820-003,	4861,	
A4010-0090.	5161.	

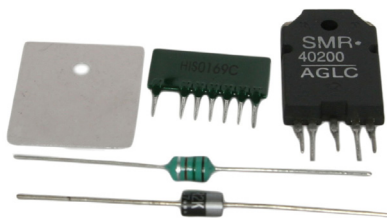

### HOZKIT SAMSUNG/AKAI

#### Horizontal Kit

A cap, resistor and inductor.

Suit	Code
CB515F, Z, CTK108, 143, CTK202, 207,	HOZKIT

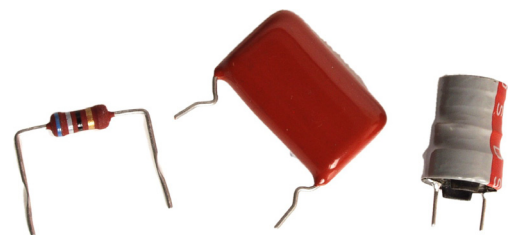

## Cabinet Parts

### TEMPEST / PALSONIC / MASUDA KNOB SET

Power knob, etc,

Suit	Code
TE1400.	KNB1400

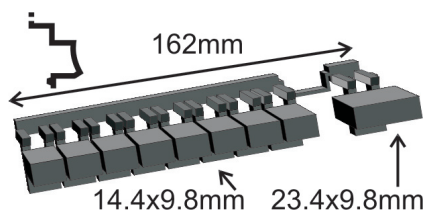

### DOOR LOCKS

As used in TV, CD and other applications.

**Code**

DL1902

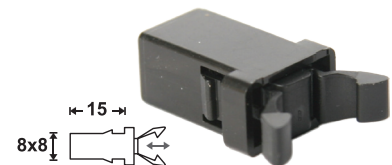





## Repair Assistance & Tools

### LCD BACK LIGHT TESTER

#### CCFL LAMP FAULT FINDER

Test and analyser for panel mounted fluoro lamps without need for dismantling the entire panel. Quick.

Code  
TL1040



### TV DEFLECTION CIRCUITS

Written by Rod Humphris of RMIT. 150 page, comprehensive reference for the repair of high voltage circuits in TV, Monitors, etc. Excellent source of information for techs' new to the field or for hardened experts who need to keep up with changing technology!

Code  
MANDEF

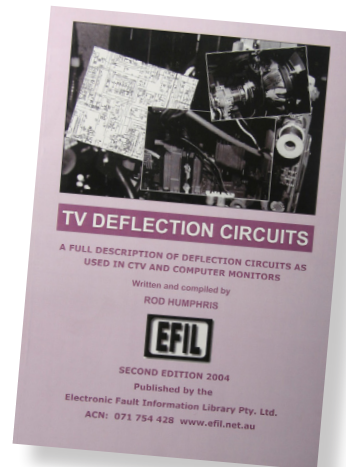

### TELEVISION L.O.P.T TESTER

This handy instrument will simulate the horizontal output of a TV to accurately test your LOPT or Diode Split Flyback Transformer. Connect the two leads to the primary, and monitoring the HV lead output, gives you a reading in Kilo-Volts. An LED will alert you to any problem and a fault code will appear on the display to confirm your diagnosis. A fully professional unit from Diemen.

Type Code  
TV STVDST01

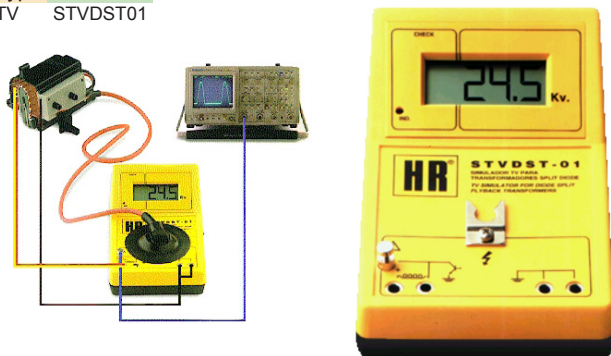

### DOW CORNING SILASTIC

Original silicone elastomer for high voltage insulating. Non corrosive & cure to a tough, rubbery solid, 90ml tubes.

Code  
SIL738



### HIGH-VOLTAGE PROBE

Measures the High Voltage circuits of TV tubes. Essential for repair. Extra safe protection 1GΩ. 40KVp-p. ±2%

Code  
HV40



### SILICONE GREASE COMPOUND

Highest quality electrical insulator, moisture repeller. Eliminate HV tracking. Lubricate joints, etc. Non-toxic MIL-1-8660B. eg. Car ignition switches, HV pix tube connections, etc.

Code  
SCO35SL







## Repair Assistance & Tools

### ISOLATION TRANSFORMER

For safety's sake and to enable the use of instruments such as a CRO, etc.

Current	Code
1 AMP	TDB240-240
2 AMP	TDB240-500

See Section POWER



### TV VARIAC

Variable Mains AC Supply "Auto-transformer" type Mechanically adjustable Adjust from 0 to 270VAC Note: Not an isolation type transformer ! The neutrals are common, Not for Live TV Chassis.

Current	Code
2A	VRC2
4A	VRC4



PICTURE MAY VARY

### CRT DEGAUSSING WAND

This powerful wand does the job right the first time, every time. Manufactured in Australia, it plugs straight into 240V.

Code
XT8150



### VGA ANALOGUE PATTERN GENERATOR

#### PC/HDTV Hi-Res Component or RGB

HD15 break-out lead for testing Multi-System TVs, PCs, etc. Compact metal box portable. OSD Menu/Res/Refresh display. 27 patterns. RGBVH. YPbPr. www.cypress.com.tw

Output	Code
VGA & YUV	CPA-1

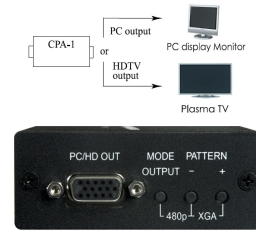

### DVI INTEGRATED PATTERN GENERATOR

#### PC/HDTV DIGITAL/ANALOGUE

DVI-I 29 Pin D shell connector Analogue VGA or Digital output Multi-System TVs, PCs, etc. Compact metal box portable. OSD Menu/Res/Refresh display. 27 patterns. RGBVH type DVI www.cypress.com.tw

Output	Code
DVI-D	CPA-2



### HDMI VIDEO PATTERN GENERATOR MOTION

This is a wide variety of PC and HD pattern for stable test signals. Use the keypad or remote control to select patterns and timing.

- HDMI v1.2, HDCP1.1, DVI1.0, 1.65Gbps
- PC: VGA to WUXGA @ 60Hz.
- HDTV: 576p to 1080p-50/60Hz.
- HDMI & DVI (Adaptor)
- 36 patterns. Motion running block
- 8CH Audio
- VESA EDID v1.3, EIA/CEA 861 V3.0

Output	Code
HDMI 1.2	CPA-4



### 3D MINI HDMI ANALYSER

#### HDMI SOURCE ANALYSER

Checking both source and display devices. LED can show status of both input and output device. The major purpose is to analyse input source info-frame and output sink EDID.

- Another purpose is to use built-in pattern to test output device.
- SD, HD up to 1080p, PC up to WUXGA and 3D
- Generates 25 timings and 6 patterns
- Deep colour video (12bits/colour)
- Analyse input source info-frame and output sink EDID
- Touch button control function
- OLED show Input / Output timing information.

Output	Code
HDMI 3D	CH-A1



### HDMI V1.2 PATTERN GENERATOR

#### HDMI OUTPUT WITH AUDIO

Tool for evaluation testing of displays/panels. Up to 4095 types of video testing signals. Supports audio testing with built-in sine wave, external analog audio, and external digital audio input through S/PDIF. Control is simple yet comprehensive with on-panel buttons or remote controller to select from the timings, patterns, color spaces, DVI/HDMI output, etc. Bundled Windows software application to perform advanced control timing/pattern programming, EDID reading/writing.

- Provides total 39 Timings and 39 Patterns
- Supports HDCP signal verification pattern
- On-panel LED display and LED indicators
- Remote control and RS-232 control

Code
CPHD-1

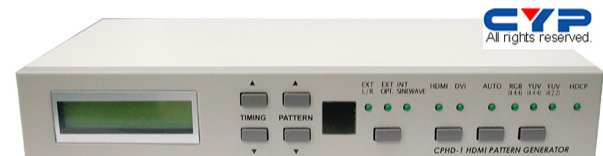



## □ Flyback Transformers

### EHT TRANSFORMERS & HIGH VOLTAGE UNITS FOR CRT CATHODE RAY TUBE TELEVISION SETS

#### AKAI KONWA

See Also Samsung, Goldstar, Daewoo & Vision1

Details	Code
CTK146 CF0304 101-2140-1703 & HR7491	EHT182
CTK206 CF0301 101-2200-0503A	EHT183
CTK115 CTK202 (20") FCM2015AL	EHT285
CT2570 4515 0344	EHT6182
CT2869 4515 0378	EHT6160
CT2568AT CT2868AT 101-228002-06	EHT8183
CT2567AT TLF70238 HR8121	EHT8121
CTK280 101-226003-01A TLF70177A (CTK280 had two chassis)	EHT7920
CTK280 CT2867AT 101-226002-01 101-226003-06 101-226006-03 (CTK280 had two chassis)	EHT8573

#### AIKO - DAEWOO - NEC - TEMPEST - TEAC

Tempest TE10RM etc 101-2100-0103	EHT180
Tempest TE34RM CF0304, 101-2140-1703	EHT182
Tempest TE48RM CF0301, 101-2200-0503A	EHT183
Tempest TE1400 FCV-1422L01	EHT184
Tempest TE34RM FC-1445, KFS60893	EHT188
Tempest SP48RM SP20RMT KFS60506B	EHT190
Tempest SP1400R AIKO ATV3414 BSC222952 13/23V01G	EHT191
14" TV, CB336, CB339K, TE14F FCM1415AL	EHT280
TEMPEST SP5997RM FCR29A015	EHT301
AWA C3425 (C43M) NEC N3419 N3420 N3442 14" KFS60226B	EHT315
DCF1577A Suit 14" and equiv NEC N3441 Tempest TE14FC/RC	EHT305
DCF1577N ** N VERSION OF DCF-1577 **	EHT304
Tempest, NEC, AIKO and others DCF-2052	EHT308
DCF2077, NEC N4845 C4823 SC2037VR TE20R/RC/RM/RMT 79TD0943	EHT310
DCF2077N, HR7481 NEC DCF-2077N	EHT311
DCF2077A, HR7455 FAT30010	EHT312
NEC N4830/40/46 20" KFS60266/B 79TD0498	EHT316
NEC KFS-60280	EHT317
NEC FS5111 47105367	EHT497
NEC FS6390 FS6395 47105380	EHT498
NEC N4886 47105329	EHT501
NEC C1816, C2061 4710 5118	EHT5118
NEC 4710, 5123, 5125	EHT5125
NEC C2617,18,35,36,61,70 4710 5125	EHT6495
NEC 47105180 ST2102, ST2103, C1817,C1901,C2026,62,63,71	EHT5180
NEC 47105180 Replacement	EHT7651
NEC 47105233	EHT5233
NEC 47105402 FS5180	EHT5402
NEC 47105433 FS6391 FS6802 MSU1FVK	EHT5433
AIKO ATV6800S 154179Z	EHT7645
NEC N3405 47105289	EHT7865
TEAC 50H0000152 MV1421 MV1422, DAEWOO DTC14Q1-TX(&20,21") HST1142.5057 50H0000177 HR7880	EHT7880
AWA 3402AV JF0208-0208,0218,0230, 586530902	EHT7971
DCF2217J HR7644 MV4850 TEAC	EHT7644
NEC 047105198	EHT7678
DAEWOO DT29G1 1352-5008	EHT7927
DAEWOO GREATZ PIONEER 3051504 29P1TL4XT	EHT8007



#### AWA - THORN - BAIRD

AWA C660, THORN 9405, BAIRD 9201C and 334B04102 & OTHER "N" CHASSIS TYPES	EHT196
BAIRD CTS132 AT2070/70A	EHT6070
THORN 22ND5	EHT7026
AWA 4850 HR7806	EHT7806

AWA See also AIKO

#### BLAUPUNKT

HR2458 FAT210-17	EHT145
IS70-70 29201-025-02	EHT5717
HR5702 FAT3761 MS70-78BVT FM100-40 2920101901/2	EHT5702
8667210473	EHT6304
HR6311 FAT210-311	EHT6311
HR6321 FAT3616 8667210401	EHT6321
HR6332 8667210522	EHT6332
7660530, 7661460/70 IS63-33/51/52 IS70-52	EHT6504

See also Grundig

#### DIETRON

KFS60676, DMQ2147	EHT7736
-------------------	---------



Details	Code
<b>FUJITSU GENERAL</b>	
11320027	EHT6072
FGS250 472502-00/01 HR6163	EHT6163
FGS282TXT 63206300	EHT6248
FGS211B, 251P, 281P, 47272502, 632048000	EHT6271
FCV1010E02	EHT7273
MSH536 GC208	EHT7449
154-165C 591105018A-AA	EHT7483
MSH-1FBW24A	EHT7490
FG1441 154-2164A 5908-0512A-AA	EHT7620
MSH1BW03 MSHIFCE01 GC148	EHT7640

## GENISYS

154-277B 20" C2101	EHT7432
See also GOLDSTAR & SAMSUNG	

## GE - GENERAL ELECTRIC

C2617,C2618,C2635,C2636,C2661,C2670 47105125 Orig	EHT5125
47105125 Replacement	EHT6495
FCV1410E12A 146P220A	EHT7261
104525 30 TX92 Chassis 29GP480 29GS6AH	EHT7360

## GOLDSTAR - ESC - LG - PALSONIC - PRINCESS - TEAC - AKAI

PALSONIC 3438 CF0304 101-2140-1703	EHT182
KFS60506B	EHT190
154-168G 154-207E CTK2175	EHT7908
154-125A 154-132A 14CT9	EHT320
154-177B CTM141	EHT325
154-194E	EHT327
154-189H CTM340-MK2	EHT328
154-279C CTM711S	EHT329
154-138H BSC231108 KFS60282 HR7679 CTV1466,3455,3458,3488	EHT330
154-138P/T BSC25-1102 CF93221 HR7474 CTV4868,4878,4889	EHT332
154-277B Genisys 20" C2101	EHT7432
5908-05009A-AA DFN-FC1401 ESC CTV1428	EHT7452
154-189C CTM314	EHT7457
154-138K HR7462	EHT7462
154-138N	EHT7607
154-2164A FG1441	EHT7620
154-179Z ATV6800S CTM715S	EHT7645
154-177S CTM205	EHT7666
154-125C	EHT7668
154-166B 9809-42400 1420/22/23/60 MCH4175	EHT7673
154-194D	EHT7906
154-374A KFS6114 CT2877	EHT4374
154-064J CH14A57 HR7902	EHT7902
FCK14B025 HR7782	EHT7782
13420006/0/2/A/B 3000-2064 EU68ST	EHT8029
61742-8005E LG CA20F80	EHT8123
KFS60490 6128 & 6728	EHT8562
40348A-25 EU68ST/1	EHT8790
6174Z-6005S CT29Q12IP	EHT8811
6174Z-6005U CT29Q24ET	EHT8905
LCE-CF122A FAT30239 5908-05016A-AA	EHT30239
LG 154-382A	EHT46165



Not here? See also TEAC, SAMSUNG, AIKO, GENESIS....

## GRUNDIG

See Also Blaupunkt	
29201-029-02 IS70-70	EHT5717
29201-019-10 M70-490/9 FAT30086 HR5713-00	EHT5713
29201-029-01	EHT6500
29201-029-05	EHT6504
29201-029-08	EHT6509
29201-030-08 29201-680-03	EHT6518
29201-029-052a IS70-35VTM	EHT6574
29201-680-01 ST72-261	EHT6601

## HANIMEX

CTV10	EHT180
-------	--------





Details	Code
<b>HITACHI</b>	
2435191	EHT5191
2433442 T67S51	EHT6114
CTP2065 2432611 2432651 HR6190	EHT6190
CPT2139 2434596	EHT7145
HR7022 2433302	EHT7022
HR7032 2434453	EHT7032
HR7041 FAT3780 2433521	EHT7041
HR7105 2434451	EHT7105
HR7135 FAT3973 2433721	EHT7135
HR7136 FAT3976 2433301	EHT7136
HR7239 2435521 CMT2159	EHT7239
HR7525-02 2435192	EHT7525
HR7518 FAT3835 2434141	EHT7518
HR7557 2435501 FM200 PM51-40	EHT7557
HR7730 2435066 CL2114R	EHT7730
HR7778 2435063	EHT7778
CMT2110-194 C2114T	EHT7878
<b>HITACHI FUJIAN</b>	
BSC21-0526-5731-081A	EHT2105
HFC2111B BSC25-0120	EHT7146
<b>HMV - DECCA - FERGUSON</b>	
HR2080-10 FAT080-10 HMV C221, DECCA EZ1012	EHT10
TX100-90° FAT3538 2433892	EHT3538
TX100-100° HR7026 FAT3758 HMV-9563, 9653, FERGUSON	EHT7026
TX100-90° HR7156 FAT3497 90° FERGUSON	EHT7156
<b>ITT</b>	
003060104 7262793 4515-03-13/19 D046137	EHT6113
<b>JVC</b>	
AV28S4E AT2077-39	EHT6550
AV21-TEAV CJ27898-00AJ1 CJ28069-00AJ1 CJ28069-BJ1	EHT8269
<b>LOEWE</b>	
D108/37	EHT6100
24513 18-5 COMTUR 1270 CHASSIS E3000	EHT7378
1372-0016C 1372-0081B 276-27397-050 Suits 5684Z	EHT8421
<b>MASUDA</b>	
T109 & T1092 101-210001-03	EHT180
T2091, T2094, CF0301, FCM20A016, 101-220005-03A	EHT183
KFS60506B, K2001, HR7444	EHT7444
S21TXS, CF0467	EHT7918
<b>MITSUBISHI</b>	
334B07403	EHT370
334B07406	EHT373
334B07409	EHT376
334B07701	EHT379
334B07803	EHT382
334B07901	EHT7901
334B08108 CT2553	EHT7631
334B08105/0 334P08109/0 CT2153	EHT7685
334P15309	EHT388
334P22101 CT29ACI	EHT389
<b>NAD</b>	
Model 6380, 45150167 HR5644 FAT056-37	EHT5644
<b>NATIONAL - PANASONIC</b>	
TLF14511	EHT200
TLF14512	EHT201
TLF14556	EHT4556
TLF14565	EHT202
TLF14650	EHT207
"B" Version TLF14577B	EHT4577
"F" Version TLF14577F	EHT7824
TLF14595F Replacement	EHT7801
TLF14695	EHT206
TLF14673 TC1450	EHT208
TLF14610F	EHT210
*2 VERSIONS* Suit Remote Types TLF14612B1	EHT211
*2 VERSIONS* Suit Non Remotes TLF14612B/F	EHT212

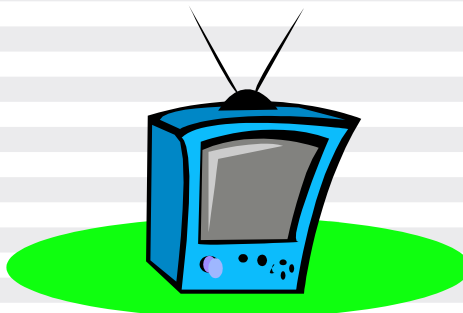



Details	Code
<b>NATIONAL - PANASONIC Continued...</b>	
TLF14736	EHT213
TLF14649	EHT215
TLF14749	EHT216
COIL ONLY SUPPLIED, Must be fitted onto existing TLF6024 ferrite Tripler is not supplied	EHT217
TLF6031B	EHT218
TLF14690F, TLF14675B	EHT219
TLF14658B	EHT221
TLF14683	EHT220
TLF14699F3	EHT4699
TLF15518F Replacement	EHT7872
TLF15602F	EHT5602
TLF6606B	EHT222
TLF6609B	EHT224
TLF15562F	EHT7714
TLF15626 TC14E1A	EHT8264
TLF15566F TX25A3 TX28W3 TX29A3	EHT8398
<b>NOKIA/ITT</b>	
D004-37	EHT6005
45150350 NOKIA 5550VT	EHT6057
45150340 NOKIA 6380VT	EHT6157
45150308 NOKIA C351VT	EHT6284
45150503,04,21 NOKIA 7163VT	EHT7214
<b>NORDMENDE - SABA - THOMPSON</b>	
HR2063-00 FAT063-00 10 PIN TYPE Nord 525 235/238/239	EHT102
HR2080-00 FAT080-00 11 PIN TYPE Nord SPECTRA COLOUR	EHT105
HR6024/6036 FAT3664	EHT6024
HR6067 FAT3816 NORD /SABA 525-599, THOMPSON 472359	EHT6067
HR6245 FAT3846 309311957 473284 00 260813 344TX0238	EHT6245
HR7032 FAT3847 NORD 2434453	EHT7032
HR7041 FAT3780 THOMPSON TS3617 2433521	EHT7041
HR7126 FAT3729 THOMPSON 440760-00	EHT7126
40011200 077863222 M5105,5107,5505,5506,5512,5515,5520,5523	EHT7128
<b>ORION</b>	
HR6468 1182-0997 TRIADE 8603	EHT6468
HR7460 371-4002	EHT7460
FCM20B043	EHT7779
HR7829 322-0016 21ST	EHT7829
1352-5006R 34BuB	EHT8416
1372 0019 S065624000 28UVA 29DUA T2900 T7800	EHT8526
<b>PHILCO</b>	
SS2500LXD	EHT7063
<b>PHILIPS -PYE- KRIESLER</b>	
HR2031-22 4822-140-10138, FAT10-138 K9, 59-01, 59-02 CHASSIS	EHT20
HR2045 4822-140-10145, FAT10-145 K11, 59-03, 59-05 CHASSIS	EHT30
HR1490 4822-140-10149, FAT10-149 KT2A-2/3, 20A-17, T36	EHT40
HR1610 FAT10-161 KT3A-2S 9 PIN	EHT46
HR2176 PHILIPS KL9/A/A1 etc PYE T39	EHT50
PYE PY101PC	EHT180
4802-140-17057 PYE 14G4, KRIESLER 37-104	EHT260
4802-140-17101 PYE (Original Sharp)	EHT265
4802-140-17101 PYE (Replacement)	EHT7050
4802-401-7129 14017129 FCC120 28CE1965	EHT129
PYE PY1401RC	EHT294
20GR1365, AT2101/01, /02, AT2102/02A, 4822-140-1379	EHT2101
4822-140-10352, 21CN4060-75 NCF TXT	EHT7500
4822-140-10246, K40 MatchLine 26"	EHT6040
4822-140-10247, KT4 MatchLine 22"	EHT6094
HR6012 4802-140-10151,17073 FAT10-151, K12, T37, T38 (Note: You may need a HV Lead with the above: Code HV4841 \$8 75)	EHT6012
36511 KT2260 KT2036 KT2226 KT2236 KT2636	EHT6096
HR6098 CTXA1S, CTXA2S 4822-140-10198,10395	EHT6098
HR6133 FAT3832 PHILIPS CTO-S 4822-140-10254	EHT6133
4822-140-10294 HR6140-04 Konig FAT3820 Chassis 2BS Replacement Type (Recommended)	EHT6140
HR6141 36832 22CE 2061/05T	EHT6141
HR6206 4822-140-10386, G110-PTV	EHT6206
HR6213 4822-140-10384,10398 G90, G110-Euro & AT2077-88E, 157-53862, 25GR97601308	EHT6213
4822-140-10325, 4812-140-10325, AT2077/88, 25CG6270, CP110	EHT6214
4822-140-10378, 28DC2070, 37971	EHT6216
HR6467 AT2077-85A	EHT6467
HR6478 4822-140-10407,10382 G110-S G111-E G111-S G112	EHT6478





## Details Code

### PHILIPS -PYE- KRIESLER Continued...

HR6581 4822-140-10408, 3122-1383-8140/1/2/3/4	EHT6581
HR6483 4822-140-10414	EHT6483
HR6484 4822-140-10399 28GR9770/28B	EHT6484
HR6489 4822-310-31892,4812-140-10275,4822-140-10275	EHT6489
HR6535 4822-140-10431,4822-140-10429, MARK2	EHT6535
HR6547 4822-140-10424, FL101, 33ML8990/6	EHT6547
HR6549 3122-1383-8220, AT2077/38	EHT6549
PHILILTA 15CE1210/22B, Chassis 30326, ARISTONA 43KE1315	EHT7503
4802-705-17151, 4822-140-10282,10326, FAT3819, CF1, 36692	EHT7505
HR7506-01, 4822-140-10349	EHT7506
HR7519, 23236052	EHT7519
HR7524, 4822-140-35353,35356 21GR9650, 21GR9750, G90B	EHT7524
HR7525, HR7525-02, 4822-140-10338, 140-20068,10338, NCF-CR	EHT7525
HR7527, 4822-140-10369, -10379, Philips-3762, GR1-AX	EHT7527
HR7541, AT2079/18	EHT7541
4822-140-10328 NC3-CR-S NCF SV00 8801	EHT7564
459700 47105198	EHT7678
20GX8350 1142-5020 4822-146-21116 4822-140-10525	EHT7789
4822-140-10548 2422-531-02149 29GX1891,1893,1896	EHT7980
4822-140-10557	EHT7815
HR7936 AT2090/18	EHT7936
4822-140-10612 14PT138A 20PT1482 HR7963	EHT7963
4822-140-10637, 21PT2622/75	EHT8124
MCS Chassis AT207820671 21HT1582 21PT3722,434,534	EHT8329
4822-140-569 21PT238 hr8304	EHT8304
2443-6994 21GX1566	EHT8318
OV 2076-21041 29PT6021 29PT6361	EHT8331
4806-140-10649,17077 1372-0001,0011 2422-531-02282	EHT8333
1352-0003 25PT468A/75R	EHT8370
4822-140-10666 29PT4273 29PT4873	EHT8380
4822-146-10961 29PT4673 29PT4473 AT2079/BO HR8380	EHT8809
26CE1991 FCC096 VE8103-4 4802-142-17003	EHT17003



### RCA

10566060-P2 1532873A 29DH91A	EHT8317
40337-14 R21GG8RA	EHT8314

### SAMSUNG - AKAI - PRINCESS - GAF - EXPO - TEMPEST

FCC-1415AL HR7254 MHF042-01A	EHT278
FCK-1415AL	EHT279
CB3312Z,CB5025J,CB3325J,CB3412, 14CT6,PF1 TLF770018	EHT280
FCR25A003 Replacement	EHT7623
CB230Z SP25987/RM 30E91-5085 FC31A04 KFS61416 TCG20B02	EHT289
FSV20A001 P1B SCT11B TV4861 TV5161	EHT297
FCR29A015	EHT301
FCR25A006R CDX2512 CDX2514 KH25	EHT283
FCR25A005 32859200013 CB6230WT	EHT7680
20" TV, CB514, CB515, TE20F, CB5012Z FCM2015AL CB5023J, CB5023Z, etc	EHT285
FCG1445EL CTK110,115,145,161 CB3310	EHT286
FCG2012L06	EHT7853
FCG2045 CTK211T	EHT287
FCG2045BL CB348,528,542 CTK203 P54S	EHT288
FCK14A019A CT1407	EHT7834
FCK14A033 A1201-0047	EHT7843
FCM20A023 CB53187	EHT7617
FCM2015HE OKI-532 HR7902	EHT7929
FCM2015ML CW5029	EHT7605
FCM1411-01 2859154052 32859154052	EHT7618
FCR2615AL CB667	EHT290
FCM20A015 CB5051,5312,5322,5324, P58SC RM109 TV484R1 TV514	EHT296
FSV20B001 CS5377W SCT12A	EHT298
FTK20R002 TVCR514	EHT292
FCM20B022 154-277B	EHT7432
CTK2175, 154207E	EHT7908
FCR29A014R AA26-30001M TV685 TV686-(See EHT7968 too)	EHT7614
FTH29A001 TV686 (Beware! 2 Chassis this model)	EHT7968
AA26-30001K CB6330Z CDX2512 CDX2514 KH25	EHT7955
AA26-30002W TV686	EHT8093
AA26-30002P FCZ29A002 CS7277PF	EHT8854



### SANYO

610-017-8991 FD0039 CPP3005-VR00 CPP3033-00	EHT61
CPP6101VBT FD0003	EHT63
FD0034	EHT64
FD0024	EHT66
FD0187 FD187 610-207-8022	EHT72
HR3606 FO210 (Not "A")	EHT65





Details	Code
<b>SANYO Continued...</b>	
HR3607 FAT3712 FO227 CTP7605/7/8	EHT79
HR3608 FAT3713 FO234 or FO210A ("A" Only!)	EHT80
610-018-6286 F1111	EHT85
F1141	EHT90
FD0125 CCP3002	EHT1250
F1143	EHT6143
F1143A CTP6190,6210,6226,6238,6281,6631	EHT6267
610-018-6859 F1162	EHT6482
FD0199 HR7627	EHT7627
<b>SCHNEIDER</b>	
1372-6009A 3210	EHT8431
1372-0033 FAT30717 2810	EHT8620
<b>SHARP</b>	
RTRNF0027 RTRNF1751 CX3451	EHT7675
RTRNF0063 CX34A1 CX34A3	EHT235
RTRNF0069 CX51B2 CX51B4 VT5128X Replacement	EHT7711
RTRNF1154 14G4 37-104 37-133 5907 9C145	EHT260
RTRNF1182 CX2010 CX2020 CX2031 CX2071 Replacement	EHT6396
RTRNF1205 CX2220 CX2270	EHT1205
RTRNF1210 CX1881	EHT1210
RTRNF1220 CX1461 CX1481 34PT2	EHT265
RTRNF1220 CX1461 CX1481 34PT2 Replacement	EHT7050
RTRNF1257 CX2232 CX2272 F1257CE Replacement	EHT7348
RTRNF1287 DV1600	EHT240
RTRNF1318 CX2033 CX2074 CX2083 DV2095 DV4884	EHT244
RTRNF1349 CX2273	EHT1349
RTRNF1366 CX6374 CX6375 DV2695 DV6384 Replacement	EHT6610
RTRNF1382 CX4814 CX4834 CX4844 LX4814	EHT1382
RTRNF1412 CX3434 CX3465D	EHT250
RTRNF1412 CX3434 CX3465D Replacement	EHT7753
RTRNF1630 CX3436S	EHT270
RTRNF1580	EHT268
RTRNF1625 CX6336 CX6337 CX6366 CX6376 CX6376A CX6378 CX6379 DV6386 Replacement	EHT7790
RTRNF1687 CX3437 CX3447 CX3467 CX3478 Replacement	EHT7773
RTRNF1689 Replacement	EHT7748
RTRNF1691 CX2048 CX2078 CX4838 CX4847	EHT273
RTRNF1717 SV2878 SV2878NZOS	EHT7758
RTRNF1780 CX6349 CX6352 CX6359 CX6362 DV6389 DV6686 DV6389 Replacement	EHT7732
RTRNF1783	EHT6167
RTRNF1856	EHT7870
RTRNF2000 SV6689X	EHT6256
RTRNF2006BM XV6689X	EHT7531
RTRNF1754 33S21A/1/S DV7988X SV3320H	EHT8815
RTRNF0045 CX5151	EHT8816
<b>SONY</b>	
1-439-332-00/11/21 KV2764	EHT6400
HR6401 1-439-332-31	EHT6401
HR6403 1-439-332-42	EHT6403
HR6405 FAT3932 1-439-288-00/12	EHT6405
HR6407 FAT3913 1-439-280-00/13	EHT6407
HR6408 FAT3918 1-439-303-00/11/31/32	EHT6408
HR6409 FAT3910 1-439-244-00/11/21/31	EHT6409
HR6410 1-439-243-11	EHT6410
HR6412 1-439-286-00/11/12/13/21 KV2210 to KV2224	EHT6412
HR6414 FAT3912 1-439-276-21	EHT6414
HR6413 1-439-289-00 KV2782	EHT6413
HR7245 1-439-423-21/31 KV2183	EHT7245
HR7244 1-439-416-11/12/21/23/41/51	EHT7244
HR7337 1-439-423-61/62	EHT7337
HR7401 1-439-331-41	EHT7401
HR7402 1-439-387-11/21 KV21XRD	EHT7402
HR7403 FAT3929 1-439-363-11/21	EHT7403
HR7405 1-439-294-21	EHT7405
HR7406 FAT3919 1-439-311-21/22/23	EHT7406
HR7407 FAT3920 1-439-311-00/11/13/31	EHT7407
HR7408 FAT3926 1-439-333-00/11/12	EHT7408
HR7777 1-439-530-21 KV2185	EHT7777
1-433-307-11 1-453-248-11 1-453-248-21 8-598-994-10	EHT8569
1-453-284-11 1-453-297-21 8-598-831-01 NX4009 KUX29	EHT8577
1-453-219-11 8-598-976-00 KVT29-SF1,8	EHT8578
1-453-326-11 8-598-836-01 KVES34M31	EHT8580
HR8662 1-453-250-11 8-958-811-00 KVG21S2 KVJ21SZ2	EHT8662
1-453-180-11 NX-1721-M3A	EHT8807





## Details Code

### TEAC SEE ALSO GOLDSTAR, SAMSUNG, AKAI / KONWA

CTM342H CF0801-3701 001-214701-13 RMT344	EHT303
CTF683, 001-234234-10 JF0101134A	EHT309
CTM1401 JF0208-0205 58-63703C-03 BSG2516	EHT319
CTM20RC	EHT320
CTM145, CTM215	EHT327
CTM340 MK2 154-189H	EHT328
CTM28S LCE-CF122A FAT30239 5908-05016A-AA	EHT30239
CTM28SRCT HR6170 3243-31692	EHT6170
CTM483 FAT30050 KFS60371D 154-177N	EHT7437
CTM485, CTM486 FCM20B027	EHT7438
CTM48RC PA02404200 HR7612 FCM20B010	EHT7612
MV1440 152-591 1810951	EHT7464
CTM205	EHT7666
MV1480 FCK14B2	EHT7687
CTM204 FCM20B031 FCM203034 9A0147100	EHT7691
CTM344 FC1434	EHT7729
CTM511S 154-277C	EHT7806
CT1406 FCK14A019A HR7834	EHT7834
CTM1413 JF0208-0208,0218,0230, 586530902	EHT7971
EU34T EU34TB 30002050	EHT7950
43-74/1402F MV1416P	EHT8361
EU68ST 30002064	EHT8029
EU68ST1 40348A-25	EHT8790
EU80ST 30002055	EHT8339
JF0101-0101 CTM596S CTM661R	EHT8921
EU684F	EHT8955



### TELEFUNKEN - B & O

8669435203 MS63-79-VT FAT30323 HR5721	EHT5721
309311957 FAT3846 HR6245 472384 00	EHT6245
309311979	EHT6354
FAT3834 AT110/27/07 AT110/27/17	EHT7311
309-311-973 243-5671 MP143VTH	EHT7172
309-311-980 243-5675	EHT7274
AT90/25/03 AT90/25/06 Model 1440	EHT7302
AT90/25/15F Model 5216	EHT7303
AT110/25/01 AT110/25/1000	EHT7305
HR7306-01 FAT3688 AT110/26/01 or AT110/26/02	EHT7306
AT110/26/15 Model 1590	EHT7307
AT110/26/05 HR7308	EHT7308
AT110/26/05F AT110/25/05F AT110/25/15F HR7309	EHT7309
AT110/27/23 HR7320	EHT7320
AT110/25/22 HR7321	EHT7321
TX92 & TX29F Chassis DS297AHX	EHT7360

### TOSHIBA

140E7A FCM1415AL	EHT280
200E7A/R7A FCM2015AL	EHT285
TFB4012AD	EHT4012
TFB4012BD	EHT4013
TFB4032AD/BD 158R6A HR7723	EHT7723
TFB4038AD	EHT4038
TFB4048AD HR7451 187E5A	EHT7451
TFB4039AD HR7479 199R4A	EHT7479
HR7519 TOSHIBA 14" 23236052	EHT7519
22236083 T23236083 TFB4067BD 207E7AK	EHT7654
TFB4062AD 3714004 12-Pins	EHT6355
TFB4062AD PW5940 289T6B 10-Pins	EHT7657
TFB4086AD 289D8A	EHT7655

### VISION ONE

VIS100R DXT717 CF152B	EHT152
FCK14A009 VIS146R	EHT294
FCM20A021 VIS240R	EHT295





Details	Code
<b>ARCADE MACHINES</b>	
28028500 HANTAREX POLO-1 25" TO 28"	EHT6209
28020280 HANTAREX POLO 1/2/28, 25" to 28" 15K/24K	EHT7375
53X0528-001 WELLS GARDENER U5000, etc	EHT7717
KFS61088, TCF8113, KORTEK 25"	EHT46217
KFS60291, KORTEK 20" VLT	EHT60291



See Also Computer Monitor LOPT Listing...

## MONITOR COMMODORE/PHILIPS LOPT VARIATIONS

Details	Code
P/Nos. 4822 1401 0349, AT2079/30101 and AT2079/30102 *8 pins plus focus/screen earth. Suit Commodore 1084SP, Mercury Monitors, Philips CM85,87,88,8833.	EHT7506
P/Nos. 4822 1401 0381, AT2079/37591 *7pins plus focus/screen earth Suit Commodore 1084SP1, 1084SP1AU, Atari SC1435, Acorn AFK17, Philips CM12	EHT7533
P/Nos. 4822 1401 0275, 4812 1401 0275, 4822 3103 1892,AT2076/367 7 pins plus focus/screen earth. Suit Commodore 1084AU	EHT6489

## COMPUTER MONITOR LOPT

Details	Code
3F14001 AMSTRAD	EHT421
47F130210 CTX CVP5468, TP250	EHT432
LCE-CF0456 19-70018-001 LG/GOLDSTAR TOBISHI ACER-7156L	EHT456
40111 (440-005-00) LIBERTY 396B2M	EHT478
420007-01 WYSE 50 , 80-004-08 ALTOS 3	EHT482
429014-06 WYSE 55 , MFB-23/363 E144238 960806	EHT483
420016-01 WYSE 60 (TMF2500B)	EHT485
420015-01 WYSE 99	EHT488
420031-01 WYSE 30	EHT495
IBM3180, (see above) 74730103437, MAT3038, MD080A, HR46030	EHT515
MSH1FBU113	EHT568
TFB4806 FEA306 Packard Bell 6133048061 078b-01-32	EHT605
AT2077-80 IBM 3192	EHT655
AT2077-46R IBM 3192	EHT659
AT2077-81	EHT662
OSBORNE M0215NL/LR 312213830161 AT2090-09 MAT33197	EHT3161
TLF14556F PANASONIC	EHT4556
ITT 3786, 45150326	EHT6089
28028500 HANTAREX POLO-1 25" TO 28"	EHT6209
AMSTRAD CTM644	EHT6355
HR6489, MAT33411, E39144-36731, AT2076/36731 & COMMODORE 1084AU 4812-101-0275, 4822-1401-0275, 4822-3103-1892	EHT6489
HR7041, 2433521 COMMODORE 1901, DTX2001, THOMPSON T55152	EHT7041
OLIVETTI 28028780	EHT7194
2802080 APOLLO 28" HANTAREX POLO-2 25" & 28"	EHT7375
HR7506, 31380138 30100 COMMODORE 1084SP, MERCURY MONITORS	EHT7506
HR7533 FTR7533 COMMODORE 1084SP1-AU, PHILIPS CM 12 CGA & AT2079-37591, 4822-140-10381	EHT7533
HR7564-00, 482214010328	EHT7564
4822-140-10487 TLF73523 OSBORNE MPV1024 MSU1FGV29	EHT7641
IBM3472, 3477, etc 16F1205 HR7647	EHT7647
EMC FEA241 LR14 EF836 EF848 730-302-1433	EHT7664
7303121424	EHT7686
HR7693 PHILIPS AT2094-01, AT2090-33, IPC MONITOR	EHT7693
TLF85686B Industrial Monitor	EHT7805
AT2090/01 PHILIPS 312213837960	EHT7706
HR7708 IBM 028002 SERIES PS1, FC014030	EHT7708
ACER 7134T404, P/No CF0625	EHT7764
AT2090/51 PHILIPS OSBORNE MP15DLS	EHT7792
SAMSUNG HP COMPAQ FUJITSU FT014A041	EHT7937
IBM 6541-02S TFB4813 SAMPO 9915 FEA507 6133048131	EHT46093
HR46109 4822-140-10641, AT2090-31, 4CM1770	EHT46109
SAMSUNG 5EI	EHT46117
HR46118 4822-140-10641, AT2090-35, C2082DAS	EHT46118
LG PROVIEW 730-302-0570 FEA708 FSN15b045N	EHT46121
LG PROVIEW 730-302-564A FEA287 FSN15A008 F/S	EHT46122
154-218C/382F 6174Z2001D FMMPC11-2001 ACER DIGITAL LG	EHT46127
EPSON ELC14VGA MPR2	EHT46146
GATEWAY GOLDSTAR LG 61747-1012B	EHT46159
GATEWAY GOLDSTAR LG 61747-1012C	EHT46174
6174Z1003G iMAC-233 iMAC-M4984	EHT46176
GOLDSTAR LG GATEWAY EV500 CB575 SW57M SW575W SW75W	EHT46187

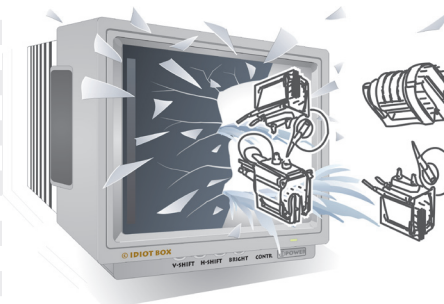





## OMB TV Support

### 30Kg MONO-MAGIX WALL MOUNT

Attractive plastic covering conceals TV wire connects and adds interior decorator styling. Suits 14"-19". 470mm arm length. Supports CRT-TV up to 30kg.

VESA	CRT-TV
Colour	Silver
Code	OMB26000



### 30Kg BI-SFERO WALL MOUNT

Aluminium CRT-TV Heavy duty strength Wall supports Painted coating. Suits 19"-21". 330mm - 465mm arm extension. Supports CRT-TV up to 30kg.

VESA	CRT-TV	CRT-TV
Colour	Black	Silver
Code	OMB06031	OMB26031



### 30Kg BI-MAGIX WALL MOUNT

Interior decorator styling. Suits 19"-21". 475mm arm length. Supports CRT-TV up to 30kg.

VESA	CRT-TV	CRT-TV
Colour	Black	Silver
Code	OMB06001	OMB26001



### 50Kg BI-SFERO WALL MOUNT

Aluminium CRT-TV Heavy duty strength Wall supports Painted coating Professional grade. Suits 21"-25". 600mm arm length. Supports CRT-TV up to 50kg.

VESA	CRT-TV	CRT-TV
Colour	Black	Black
Code	OMB452026	OMB252026



### 60Kg BI-MAGIX WALL MOUNT

Premium grade wall support with the addition of attractive plastic covering conceals TV wire connects and adds interior decorator styling. Suits 25"-32". 625mm arm length. Supports CRT-TV up to 60kg.

VESA	CRT-TV	CRT-TV
Colour	Black	Silver
Code	OMB06003	OMB26003



### 30Kg TRI-MAGIX WALL MOUNT

Full 3 point articulation. Suits 14"-21". 715mm arm length. Supports CRT-TV up to 30kg.

VESA	CRT-TV
Colour	Black
Code	OMB06004



### 30Kg MONO-SFERO WALL MOUNT

Aluminium CRT-TV Heavy duty strength Wall supports Painted coating Professional grade. Suits 14"-19". 330mm arm length. Supports CRT-TV up to 30kg.

VESA	CRT-TV	CRT-TV
Colour	Black	Silver
Code	OMB06024	OMB26024



### 60Kg TRI-MAGIX WALL MOUNT

Premium grade wall support with the addition of attractive plastic covering conceals TV wire connects and adds interior decorator styling. Suits 29"-32". 725mm arm length. Supports CRT-TV up to 60kg.

VESA	CRT-TV	CRT-TV
Colour	Black	Silver
Code	OMB06006	OMB26006



### 50Kg MONO-SFERO WALL MOUNT

Aluminium CRT-TV Heavy duty strength Wall supports Painted coating Professional grade. Suits 19"-25". 400mm arm length. Supports CRT-TV up to 50kg.

VESA	CRT-TV
Colour	Black
Code	OMB06025



### 50Kg TRI-SFERO WALL MOUNT

Aluminium CRT-TV Heavy duty strength Wall supports Painted coating. Suits 25"-29". 490 arm length. Supports CRT-TV up to 50kg.

VESA	CRT-TV	CRT-TV
Colour	Black	Silver
Code	OMB06041	OMB26041



### 8Kg SFERO SYSTEM PLUS WALL MOUNT

Suits VCR/DVD H60/105mm. 290-510mm arm length. Supports up to 8kg. Unit bracket ONLY. Suits Sfero. Two extension arms supplied.

VESA	Arms Only	Arms Only
Colour	Black	Silver
Code	OMB05042	OMB25042



ARM PAIR ONLY.  
Does NOT include TV stand (extra)

### 60Kg SLIMLINE TURNTABLE

Suits 10"-29". 360° rotation. Supports TV up to 60kg. Size 580x350x23mm

Colour	Black	Silver
Code	OMB05030	OMB25030



### 60Kg DOUBLE STAND

Suits 10"-29". Supports TV up to 60kg. Size 515x355mm. Two tier 110mm each. Two tier stand offers a storage solution for your DVD player or VCR.

Colour	Black	Silver
Code	OMB05011	OMB25011

